

# PRIXTON

# KUBRICK

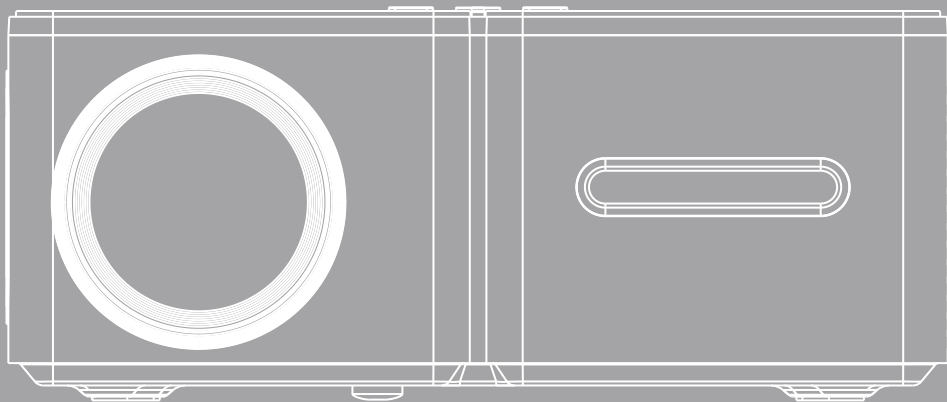

PROYECTOR PROJECTOR

---

**DECLARACIÓN DE ADVERTENCIA DE LA COMISIÓN FEDERAL DE COMUNICACIONES (FCC)****Declaración de la FCC**

Este aparato cumple la parte 15 de las normas de la FCC. El funcionamiento está sujeto a las dos condiciones siguientes:

(1) Este aparato no puede causar interferencias perjudiciales.

(2) Este aparato debe aceptar cualquier interferencia recibida, incluidas las que puedan causar un funcionamiento no deseado.

(3) El fabricante no se hace responsable de las interferencias de radio-televisión causadas por modificaciones no autorizadas o cambios en este equipo. Tales modificaciones o cambios podrían anular la autoridad del usuario para utilizar el equipo.

**Este equipo ha sido probado y se ha determinado que cumple los límites para un dispositivo digital de Clase B, de acuerdo con el apartado 15 de las normas de la FCC. Estos límites están diseñados para proporcionar una protección razonable contra las interferencias perjudiciales en una instalación residencial.**

Este equipo genera, utiliza y puede irradiar energía de radiofrecuencia y, si no se instala y utiliza de acuerdo con las instrucciones, puede causar interferencias perjudiciales en las comunicaciones por radio. Sin embargo, no hay garantía de que no se vayan a producirse interferencias en una instalación concreta. Si este equipo causa interferencias perjudiciales en la recepción de radio o televisión, que pueden determinarse apagando y encendiendo el equipo, se recomienda al usuario que intente corregir la interferencia mediante una o varias de las siguientes medidas:

- Reoriente o reubique la antena receptora.

- Aumente la separación entre el equipo y el receptor. Conecte el equipo a una toma de corriente de un circuito diferente a la que está conectado el receptor.

- Consulte al distribuidor o a un técnico experto en radio o televisión para obtener ayuda.

**Advertencias:**

El dispositivo ha sido evaluado para cumplir los requisitos generales de exposición a radiofrecuencia.

**Información sobre la exposición a radiofrecuencia**

Este equipo cumple los límites de exposición a la radiación establecidos por la FCC para un entorno no controlado. Este equipo debe instalarse y utilizarse con una distancia mínima de **20 cm entre el radiador y su cuerpo.**

Identificador de la FCC: 2ATFT-410

## LISTADO DE EMBALAJE

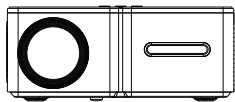

Proyector



Control remoto

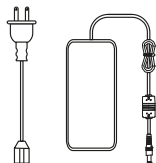

Cable



Manual

## AVISO

### Recomendado

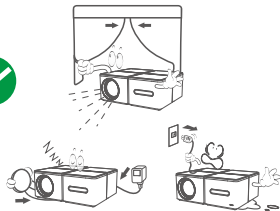

### NO Recomendado

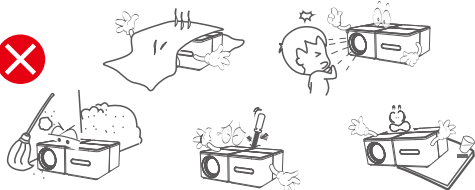

## FUNCIÓN VISIÓN GENERAL

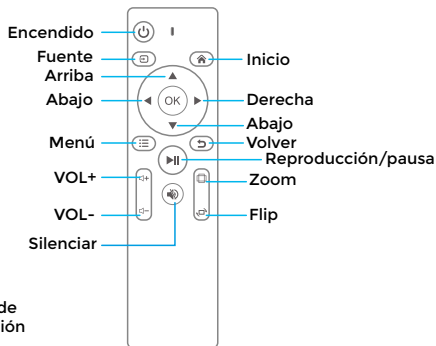
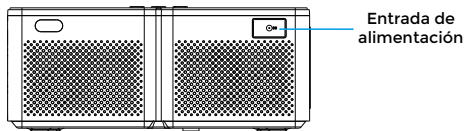
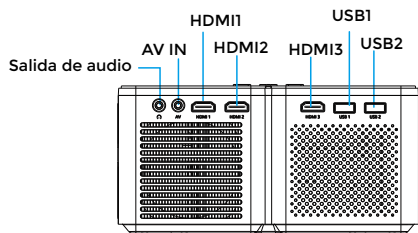
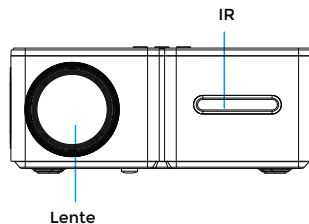
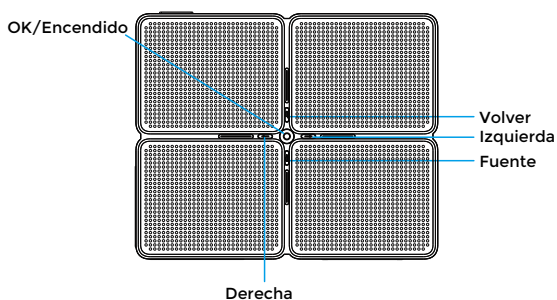

## INICIO RÁPIDO

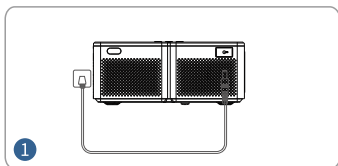

Enchufe el cable de alimentación a una toma de corriente.

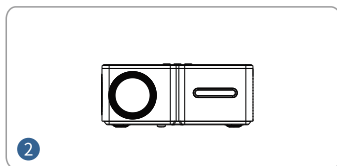

Entrada de alimentación

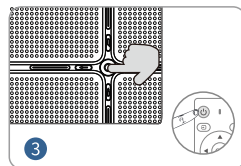

Pulse el botón de encendido para encender el proyector

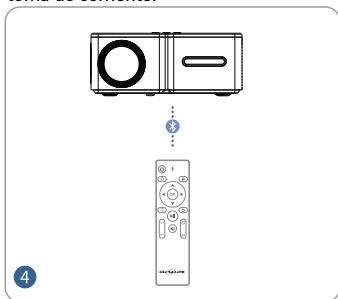

Conecte su mando a distancia al proyector a través de Conexión inalámbrica.

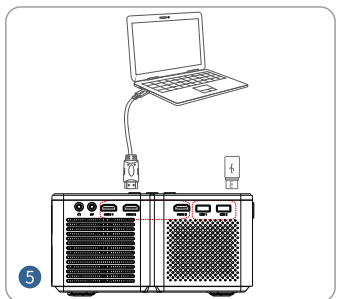

Conecte su dispositivo al proyector correctamente.

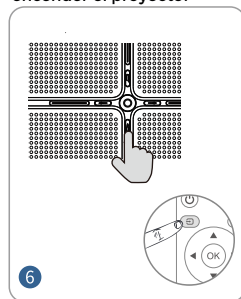

Pulse el botón Fuente y seleccione la fuente de entrada correcta.

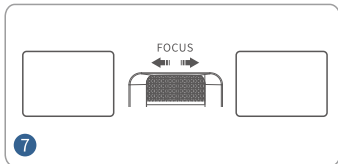

Ajuste el anillo de enfoque para obtener el mejor

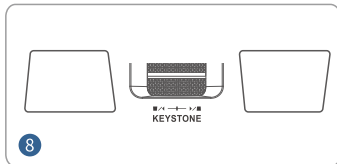

Ajuste la distorsión trapezoidal para obtener el tamaño adecuado

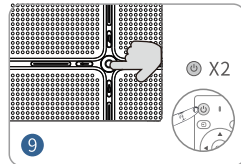

Pulse el botón de encendido dos veces

## DISTANCIA Y TAMAÑO DE LA PROYECCIÓN

Un entorno oscuro combinado con una buena pantalla de proyección mejorarán la claridad de las imágenes proyectadas.

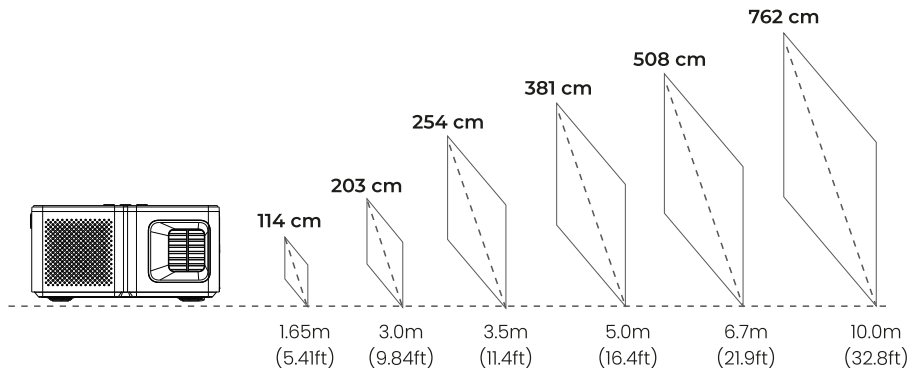

## MODO DE PROYECCIÓN

Si desea colgar el proyector del techo, necesitará un soporte para proyector.

Si desea proyectar de otro modo, seleccione el modo correspondiente en la página de configuración.



MESA DELANTERA

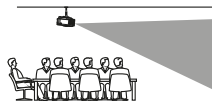

TECHO DELANTERO



MESA TRASERA

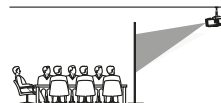

TECHO TRASERO

## ENTRADA FUENTE

Pulse (Fuente ) en el proyector o en el mando a distancia para entrar en la interfaz de la Fuente de entrada.

### A. Conexión HDMI

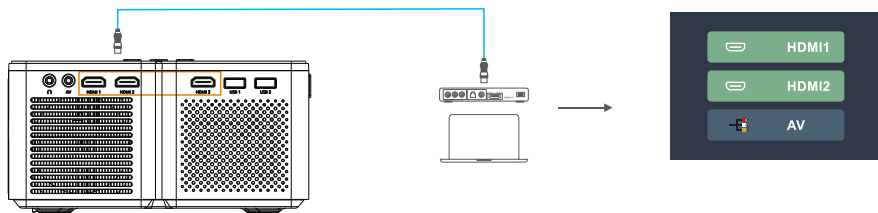

### B. Conexión AV

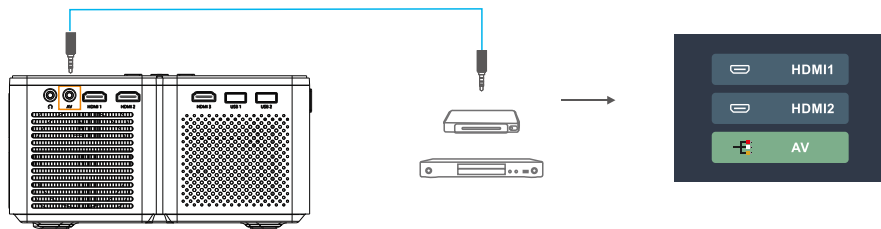

### C. Conexión USB

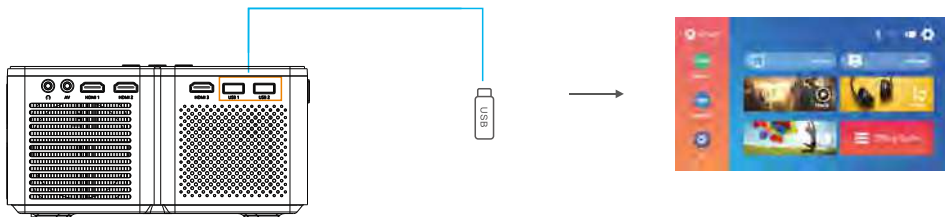

## CONFIGURACIÓN DEL REPRODUCTOR MULTIMEDIA

Cuando utilice el reproductor multimedia, elija primero la entrada correcta en la página de inicio. Si entra desde Película, SÓLO detectará archivos de formato vídeo en la memoria USB. (La interfaz de los otros tres y así sucesivamente)

### A. Ajustes del reproductor de películas



Pulse el botón **OK**

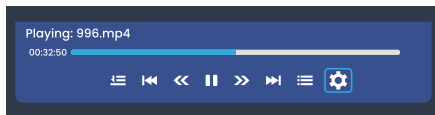
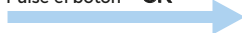

- : Modo de reproducción
- : Anterior
- : Rebobinar
- : Reproducir
- : Avance rápido
- : Siguiente
- : Lista de reproducción
- : Ajustes de reproducción

### B. Ajustes del reproductor de música

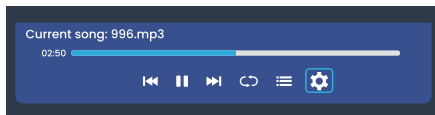

- : Anterior
- : Reproducir
- : Siguiente
- : Modo reproducción
- : Lista de reproducción
- : Ajustes de sonido



### C. Configuración del reproductor de imágenes



Pulse el botón **OK** →

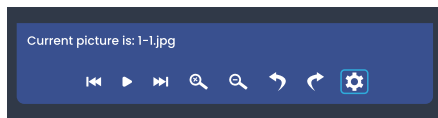

- |                      |                     |                        |
|----------------------|---------------------|------------------------|
| : Anterior           | : Reproducir        | : Siguiente            |
| : Alejar             | : Aumentar          | : Girar a la izquierda |
| : Girar a la derecha | : Ajustes de imagen |                        |

### D. Ajustes del paquete Office



- |                      |             |                             |
|----------------------|-------------|-----------------------------|
| : Acceso a la cuenta | : Compartir | : Configuración de archivos |
|----------------------|-------------|-----------------------------|

#### Nota:

1. En el paquete Office, este proyector admite la conexión de un ratón a través de la interfaz USB para realizar operaciones más detalladas en los documentos abiertos.
2. El tamaño de proyección recomendado es de 254 cm si se utiliza la reproducción de archivos Office.
3. Al abrir un archivo grande, el tiempo de apertura será más largo. Por favor, espere con paciencia a que el archivo se abra.

## AJUSTES DE IMAGEN Y SONIDO

En el modo HDMI o AV, pulse el botón Menú ≡ para entrar en los ajustes de imagen y sonido.

### A. Ajustes de imagen:

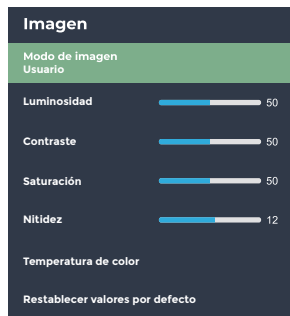

Modo de imagen	User / Standard / Vivid / Sport / Movie / Game / Energy Saving	
Luminosidad	0~100	
Contraste	0~100	
Saturación	0~100	
Nitidez	0~20	
Temperatura de color	Usuario / Frío / Estándar / Cálido	Ganancia en rojo: -100~100
		Ganancia en verde: -100~100
		Ganancia en azul: -100~100
Restablecer valores por defecto	Pulse para restaurar el ajuste original de la imagen.	

### B. Ajustes de sonido:

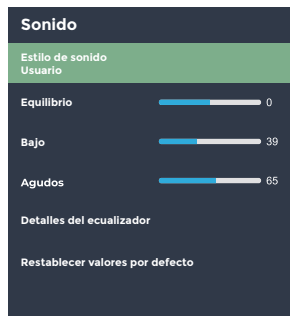

Estilo de sonido	User / Standard / Vivid / Sports / Movie / Music / News	
Equilibrio	-50~50	
Bajo	0~100	
Agudos	0~100	
Detalles del ecualizador	120Hz	-50~50
	500Hz	-50~50
	1.5KHz	-50~50
	5KHz	-50~50
	10KHz	-50~50
Restablecer valores por defecto	Pulse para restaurar el ajuste de sonido original.	

## CONEXIÓN WIFI Y DUPLICAR DE PANTALLA

### CONEXIÓN WIFI

1. Vaya a la [página de inicio](#) > [Configuración](#) > [Configuración WIFI](#)
2. Encienda el [WIFI](#) y busque la lista de WIFI mediante "Añadir WIFI"
3. Elija su WIFI, luego introduzca la contraseña para conectarse

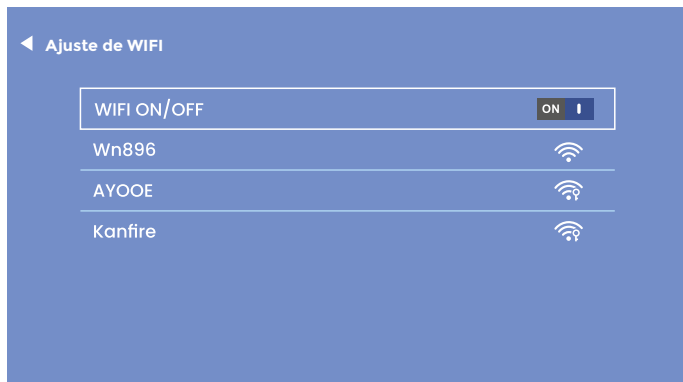

#### NOTA:

Si necesita duplicar la pantalla, la velocidad de su red doméstica está directamente relacionada con la fluidez de la **reproducción de vídeo**. Por favor, asegúrese de que la red es buena y no estar lejos del router para tener una reproducción más fluida.

## DUPLICAR PANTALLA

### IOS CAST (Para IOS System)

1. Vaya a la página de inicio > IOS CAST para mostrar la siguiente página
2. En su dispositivo iOS abra el centro de control y pulse **Duplicar de pantalla**
3. Buscando dispositivo que se pueda reflejar en
4. Seleccione BirdCast-XXXX de la lista para conectarse

**ROTACAST**

Asegúrese de que su dispositivo IOS está conectado a la misma red que su proyector



The first screenshot shows the iPhone Control Center with the 'Screen Mirroring' icon highlighted by a red box. The second screenshot shows the 'Screen Mirroring' menu with 'BirdCast-70fb' selected and highlighted by a red box. The third screenshot shows the same menu with a checkmark next to 'BirdCast-70fb' and the 'Stop Mirroring' button at the bottom.

1. En su dispositivo IOS, abra el Centro de control y pulse Duplicar Pantalla
2. Buscando dispositivos que puedan reflejarse
3. Seleccione BirdCast-70fb de la lista.

Network error  BirdCast-70fb

#### NOTA:

Asegúrese de que el proyector y su dispositivo iOS se han conectado a la misma red Wifi. Si no hay WIFI, abra un punto de acceso en su dispositivo IOS y conecte el proyector a él.

## DLNA (Sólo para dispositivos iOS)

1. Asegúrese de que su dispositivo está conectado a la misma red que el proyector.
2. Abra su software de reproducción de vídeo
3. Haga clic en el icono  y seleccione el nombre del proyector BirdCast-XXXX para conectarlo

NOTA:

1. La conexión DLNA puede funcionar en cualquier página del proyector.
2. Después de conectarse a través de DLNA, el teléfono puede seguir utilizándose con normalidad, el vídeo proyectado seguirá reproduciéndose mientras que la interfaz del teléfono móvil no se mostrará de forma sincronizada.
3. Es necesario que la aplicación admita la reproducción de videografía o screencast (algunas aplicaciones tienen restricciones sobre screencast).
4. Algunos vídeos en streaming no se pueden proyectar en pantalla debido a restricciones de derechos de autor, lo que no tiene nada que ver con el proyector en sí.

## MIRACAST (For Android System)

1. Vaya a la [página de inicio](#) > [MIRACAST](#) para mostrar la siguiente página
2. En su dispositivo Android, inicie la función Multipantalla/ Visor inalámbrico/ Duplicar pantalla/ Vista inteligente.
3. Buscando dispositivo que se pueda reflejar en
4. Seleccione BirdCast-XXXX de la lista para conectarse

**ROTACAST**

**Pantalla Android**  
Para conectar un móvil/tablet Android con un proyector basado en la tecnología WiFi-Display



1. En su dispositivo Android, active la WLAN (no es necesario conectarse a ningún router Wi-Fi)  
2. Inicie la función Multipantalla / Visualización inalámbrica / Duplicar pantalla / Vista inteligente  
3. Seleccione Android-70fb en la lista de resultados de la búsqueda

1. Por favor, recuerde abrir la función WIFI en su dispositivo Android.
2. Cuando desconecte Miracast, vuelva a conectarlo manualmente en los ajustes, o espere 1-2 minutos para que restablezca la conexión automáticamente.

# CONEXIÓN INLÁMBRICA DE AUDIO

## A. Conexión inalámbrica

1. Vaya a la (página de inicio) > (Configuración) > (Configuración Conexión inalámbrica)
2. Active la función Conexión inalámbrica y busque dispositivos con conexión inalámbricos cercanos
3. Elija el dispositivo inalámbrico correcto para conectarse



### NOTA:

1. La función Conexión inalámbrica es ÚNICAMENTE para la transferencia de audio con dispositivos de audio. NO admite la sincronización de vídeo con teléfonos inteligentes.
2. Si desea conectar su auricular/altavoz con puerto de audio, desconecte primero el dispositivo de audio inalámbrico del **proyector**.

## B. Control remoto por conexión inalámbrica

En la primera puesta en marcha del proyector, aparecerá la página siguiente para guiar la conexión del mando a distancia inalámbrico.

Mantenga pulsados los botones izquierdo y derecho al mismo tiempo durante unos segundos para establecer la conexión. Una vez conectado, el funcionamiento del mando a distancia será más sensible y la cobertura más amplia.

### Control remoto por conexión inalámbrica

1. Mantén pulsadas las teclas ◀ izquierda y derecha ▶ durante unos segundos para acceder al modo de emparejamiento automático (RECOMENDADO)

2. Pulse el botón OK para entrar en la configuración de la conexión inalámbrica del sistema para el modo de emparejamiento manual.

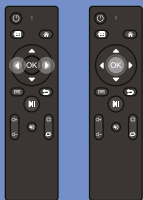

#### Dos modos de control remoto:

1. **Detección de infrarrojos común:** necesita apuntar a la ventana de infrarrojos del proyector y funcionar dentro del rango de detección de infrarrojos.
2. **Control remoto por Conexión inalámbrica:** una vez conectado el mando al proyector a través de conexión inalámbrica ya no está limitado por la zona de detección, lo que resulta más sensible y cómodo de utilizar.

#### Nota:

Una vez conectado el mando a distancia inalámbrico, los demás dispositivos de audio inalámbrico también pueden conectarse sin problemas.

Por favor, mantenga activado la conexión inalámbrica del proyector para asegurarse de que el mando a distancia inalámbrico puede conectarse y funcionar con normalidad.

## AJUSTES DE PROYECCIÓN

### A. Ajuste sencillo (Keystone manual)

1. Introducir **ajuste de imagen**
2. Elija **Clave Avanzada**, pulse el botón Derecho ► o Izquierdo ◀ para convertirlo en **Modo Frontal**
3. Elija **Keystone manual**
4. Pulse los botones Izquierdo ◀ y Derecho ► para ajustar el ángulo trapecoidal vertical ( $\pm 50^\circ$ ).

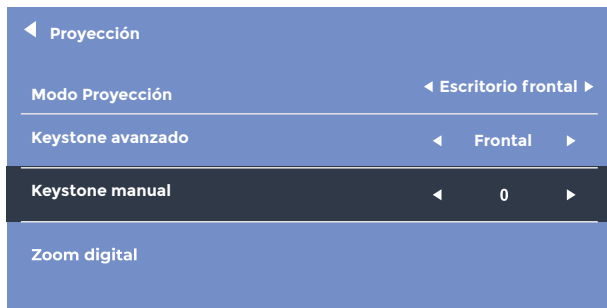



## B. Ajuste avanzado (Keystone avanzado)

Este ajuste le permitirá ajustar de manera independiente cada esquina de la imagen proyectada sin tener que mover el proyector. Mediante esta función puede proyectar desde un lateral.

### 1. Introducir (ajustes de imagen)

2. Elija (Keystone Avanzada) pulse el botón Derecha ► o Izquierda ◀ para convertirlo en **Modo Diapositiva**

3. Elija (Keystone de 4 puntos)

4. Pulse los botones de dirección ◀▶ para ajustar el ángulo, pulse el botón OK para saltar al siguiente ajuste de la esquina.

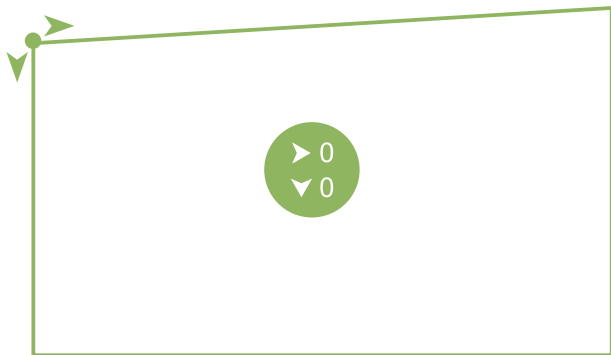

"OK" Seleccionar "◀▶" Ajustar "↶" Atrás "☰" Reiniciar

NOTA: Si desea volver a los ajustes originales, pulse Menú ☰ Restablecer.

## C. Zoom Digital

1. Introducir **(ajustes de imagen)**
2. Elija **(Zoom digital)**
3. Pulse el botón Abajo ▼ para alejar la imagen (100%-50%) y el botón Arriba ▲ para acercarla (50%-100%).



“ ◀ ▶ ” Ajustar

“ ↶ ” Atrás

“ ≡ ” Reiniciar

NOTA: Si desea volver a los ajustes originales, pulse Menú ≡ **Restablecer**.

## OTROS AJUSTES

### A. Opción de fuente de arranque: OFF/ HDMI 1/ HDMI 2/ AV.

Elija si lo desea una de las entradas para que sea seleccionada automáticamente tras encender el proyector.

(El ajuste por defecto es OFF)

### B. Opciones de encendido: En espera/ Directo

(El ajuste por defecto es «En espera») Si lo cambia a Directo, tenga en cuenta que si el proyector se queda sin corriente repentinamente mientras trabaja, deberá esperar un momento (10-20 segundos) y volver a conectarlo. El proyector se reiniciará automáticamente sin pulsar el botón «Encendido»)

### C. Ajustes de idioma

(El sistema proporciona 30 opciones de idioma, puede elegirlo según sus necesidades).

### D. Apagado programado: 10 min/ 20 min/ 30 min/ 60 min/ 120min

(Ajuste el tiempo de apagado automático según sus necesidades)



## ESPECIFICACIONES

Tecnología de visualización	LCD	Fuente de luz	LED
Resolución	1920*1080	Señal de entrada	HDMI / USB / AV
Relación de aspecto	16:9 / 4:3	Enfoque	Manual
Keystone	Keystone de 4 puntos Keystone manual	Altavoz	5W*2
Conexión inalámbrica	Versión 5.0	Fuente de alimentación	220-240V
Consumo	150W	Formato fotográfico Soporta	gif. svg. bmp. jpeg. png. jpg
Formato de audio Soporta	aac. wav. amr. flac. mp2. mp3. ogg	Formato de vídeo admitido	3gp. avi. flv. m4v. mkv. mov. mp4. mpg. rmvb. swf
Puertos	HDMI1/ HDMI2/ USB1/ USB2/ AV/ Audio de 3,5 mm	Tipo de instalación	Instalación en mesa/ Instalación en techo
Dimensión de la unidad	278*240*108mm (10.9*9.4*4.2inch)	Peso neto unitario	2.6kg / 5.7lb

## PROBLEMAS DE ARRANQUE



¿No funciona el control remoto?

- Asegúrese de que las pilas tienen carga y están instaladas de forma correcta.
- Asegúrese de que el mando a distancia tiene la conexión inalámbrica conectada.

A



¿Imagen borrosa?

- Ajuste el engranaje de enfoque/la distorsión trapezoidal para obtener la mejor imagen.
- La calidad de la pantalla de proyección también afectará a la calidad de la imagen. Se recomienda proyectar en una pared blanca o en una pantalla de mejor calidad.

A



¿No hay sonido?

- Apague el audio Dolby en su dispositivo. (como TV stick, Roku, ordenador portátil, etc.)
- Se ha pulsado accidentalmente el botón de silencio del mando a distancia.

A



¿Apagado automático?

- Protección contra el sobrecalentamiento. Utilícelo en un entorno ventilado.
- Se recomienda desenchufar la fuente de alimentación después de utilizarla para prolongar su vida útil.

A



¿Imagen al revés?

- Pulse el botón "Voltear" del mando a distancia.
- Entre en "Ajustes de Proyección" para cambiar el Modo de Proyección.

A



¿Los contenidos de HULU, Netflix y servicios similares no pueden reflejarse o emitirse?

--Debido a la restricción de derechos de autor de Hulu, Netflix y servicios similares, los contenidos no pueden proyectarse.  
--Si es necesario reproducir estos videos, utilice un TV stick, Roku o Chromecast (no incluido).

A



¿El stick de TV no puede conectarse completamente al puerto HDMI, no funciona?

--Generalmente el stick de TV vendrá con un cable extensible en el paquete, conéctelo a través del cable extensible.

A



¿Punto negro en la pantalla?

--Limpie el objetivo con un paño seco y limpio para eliminar el polvo del objetivo.  
--Golpee los lados superior, izquierdo y derecho de la máquina varias veces con un poco de fuerza para eliminar el polvo del interior del objetivo.

A



¿Faltan accesorios?

--Si el aparato está dañado o falta algún accesorio, póngase en contacto con nuestro departamento de servicio postventa para recibir asistencia.

A

## Política de garantía

En cumplimiento de lo establecido a tal efecto por el Real Decreto Legislativo 03/2014, de 27 de marzo, se pone a disposición de los interesados, accediendo a [www.prixton.com](http://www.prixton.com), **cuanta información sea necesaria para ejercer los derechos de desistimiento atendiendo a los supuestos que recoge dicha ley, dando por cumplidas las exigencias que esta demanda de la parte vendedora en el contrato de venta.**

**Las características técnicas y eléctricas que aquí se brindan corresponden a unidades típicas y podrían cambiarse sin previo aviso con el fin de proveer un mejor equipo.**

## Declaración UE De Conformidad Simplificada

Por la presente, La Trastienda Digital SL como propietaria de la marca comercial Prixton, ubicada en Avenida Cervantes 49, módulo 25, Basauri 48970, Bizkaia, declara que el tipo de equipo radioeléctrico que a continuación se expone:

MARCA	MODELO	DESCRIPCIÓN	CATEGORÍA
Prixton	KUBRICK	Proyector	Imagen

Es conforme con la Directiva 2014/53/UE del Parlamento Europeo y del consejo de 16 de abril de 2014.

**El texto completo de la declaración UE de conformidad está disponible en la dirección de Internet siguiente:**

[www.prixton.com](http://www.prixton.com) LA TRASTIENDA DIGITAL

## **FCC WARNING STATEMENT**

### **FCC Statement**

This device complies with part 15 of the FCC rules. Operation is subject to the following two conditions:

- (1) This device may not cause harmful interference.
- (2) This device must accept any interference received, including interference that may cause

### **undesired operation.**

(3) The manufacturer is not responsible for any radio or tv interference caused by unauthorized modifications or changes to this equipment. Such modifications or changes could void the user's authority to operate the equipment. NOTE:

This equipment has been tested and found to comply with the limits for a Class B digital device, pursuant to part 15 of the FCC Rules. These limits are designed to provide reasonable **protection against harmful interference in a residential installation.**

This equipment generates, uses, and can radiate radio frequency energy and, if not installed and used in accordance with the instructions, may cause harmful interference to radio communications. However, there is no guarantee that interference will not occur in particular installation. If this equipment does cause harmful interference to radio or television reception, which can be determined by turning the equipment off and on, the user is encouraged to try to correct the interference by one or more of the following measures:

- Rearrange or relocate the receiving antenna.
- Increase the separation between the equipment and receiver. Connect the equipment into an outlet on a circuit different from that to which the receiver is connected.
- Consult the dealer or an experienced radio/TV technician for help.

### **Warning:**

The device has been evaluated to meet general RF exposure requirements.

### **RF Exposure Information**

This equipment complies with FCC radiation exposure limits set forth for an uncontrolled environment. This equipment should be installed and operated with minimum distance **20cm between the radiator and your body.**

FCC ID: 2ATFT-410



## PACKING LIST

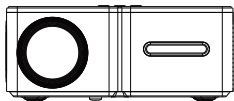

Miró Projector



Remote control

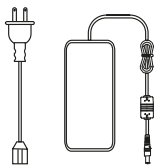

Power Cable



User Manual

## NOTICE

### Recommended

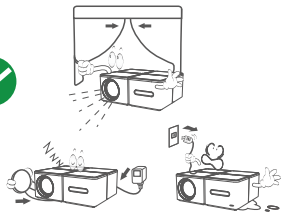

### NOT Recommended

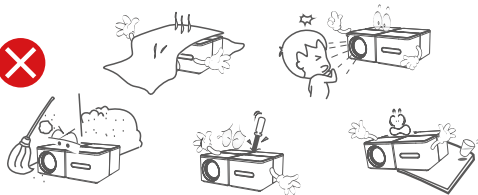

## FUNCTION OVERVIEW

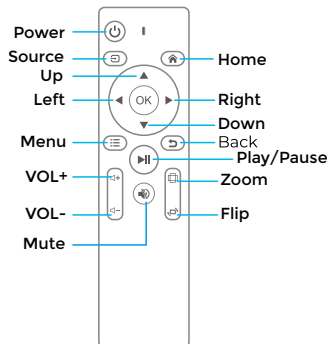
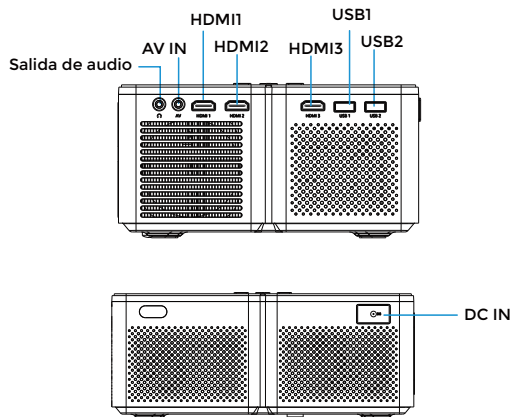
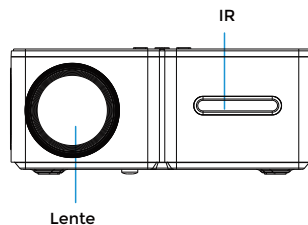
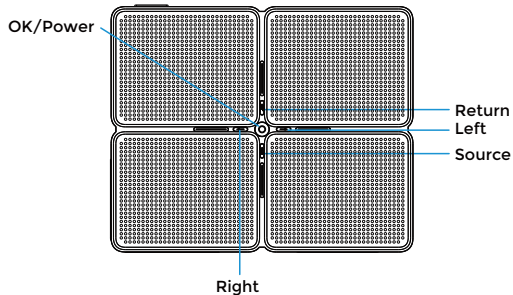

## QUICK START

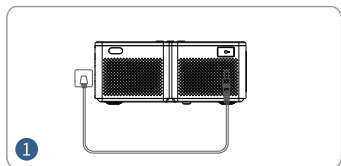

Plug the power cord into an outlet

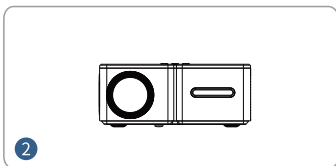

Remove the lens cover before using.

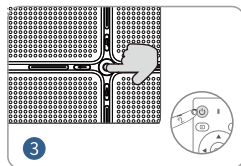

Press the Power Button to turn on the projector

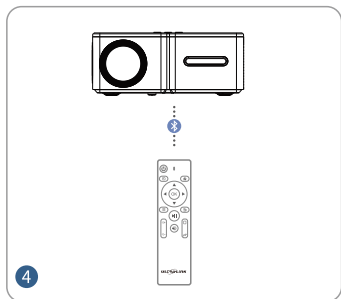

Connect your remote control to the projector via Wireless connection

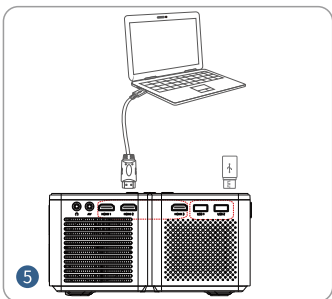

Connect your device to the projector correctly

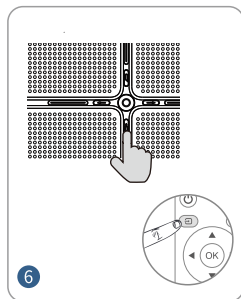

Press Source button and select the correct input source

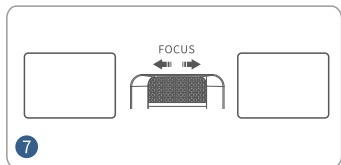

Adjust the focus ring to get the best image performance

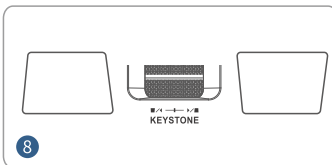

Adjust the keystone to get the suitable size

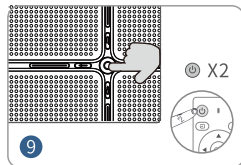

Press the Power Button twice to turn off the projector

## PROJECTION DISTANCE & SIZE

The recommended projection screen is around 80 inches with a distance of around 9.84ft. Dark environment & a good project screen will improve the clarity of the projected images.

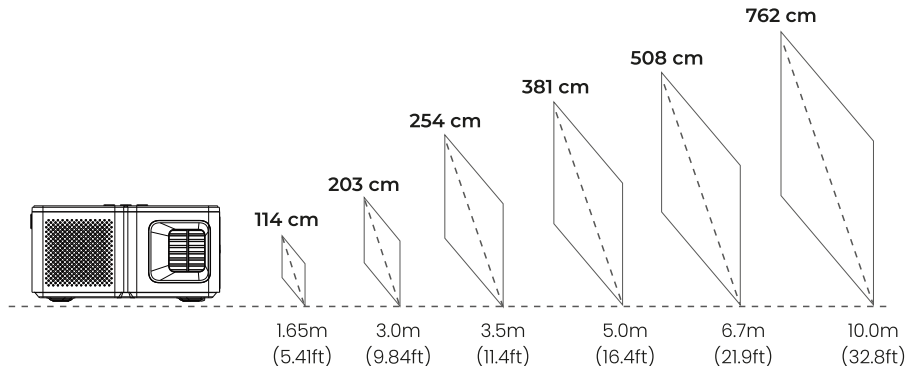

## PROJECTION MODE

If you want to hang the projector to the ceiling, a projector mount will be needed.

If you want to project in different way, please select corresponding mode in the setting page.



FRONT TABLE

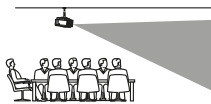

FRONT CEILING

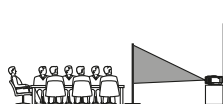

REAR TABLE

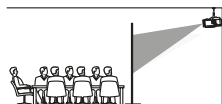

REAR CEILING

## INPUT SOURCE

Press ( Source  ) on the projector or remote to enter the interface of the Input Source.

### A. HDMI Connection

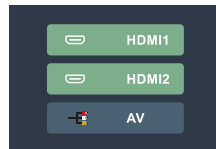
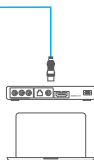
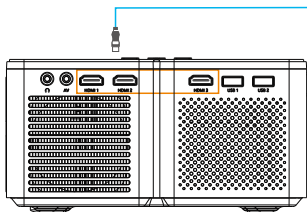

### B. AV Connection

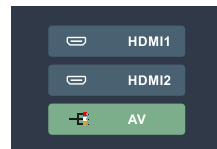
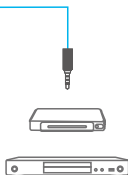
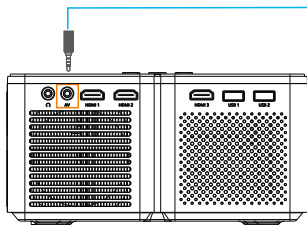

### C. USB Connection

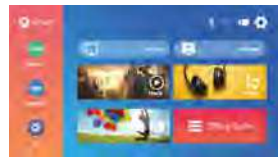
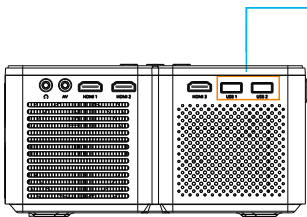

## MEDIA PLAYER SETTING

When you are using media player, please choose correct option on the home page first. If you enter from Movie, it will ONLY detect files of video format in the USB stick. (The other three interface and so on.)

### A. Movie Player Setting



Press **OK** button

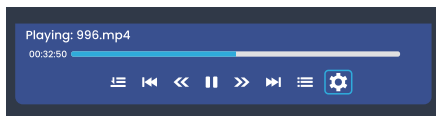

- |             |                 |          |
|-------------|-----------------|----------|
| : Play Mode | : Previous      | : Rewind |
| : Play      | : Fast Forward  | : Next   |
| : Playlist  | : Play Settings |          |

### B. Music Player Setting

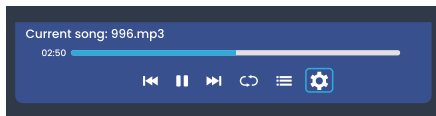
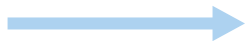

- |             |            |                  |
|-------------|------------|------------------|
| : Previous  | : Play     | : Next           |
| : Play Mode | : Playlist | : Sound Settings |

### C. Photo Player Setting



Press OK button

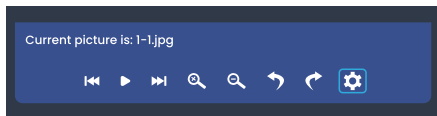
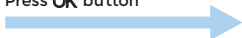

: Previous

: Play

: Next

: Zoom out

: Zoom in

: Rotate Left

: Rotate Right

: Image Settings

### D. Office Suit Setting



: Account login

: Sharing

: File Settings

#### Note:

1. In the Office Suite, this projector supports connecting a mouse via the USB interface for more detailed operations on the opened documents.
2. Recommended projection size is within 254cm if using office suit playback.
3. When opening a large file, the opening time will be longer, please wait with patience for the file to open.

## PICTURE AND SOUND SETTINGS

In HDMI or AV mode, press Menu button  to enter picture and sound settings.

### A. Picture Settings:

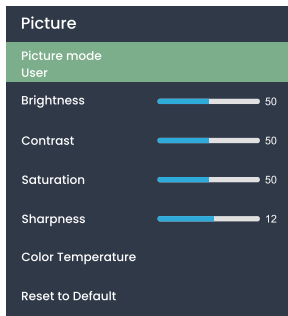

Picture Mode	<b>User / Standard / Vivid / Sport / Movie / Game / Energy Saving</b>	
Brightness	0-100	
Contrast	0-100	
Saturation	0-100	
Sharpness	<b>0-20</b>	
Colour Temperature	User/ Cool/ Standard/ Warm	Red Gain: -100-100
		Green Gain: -100-100
		Blue Gain: -100-100
Reset to Default	Press to restore original picture setting.	

### B. Sound Settings:

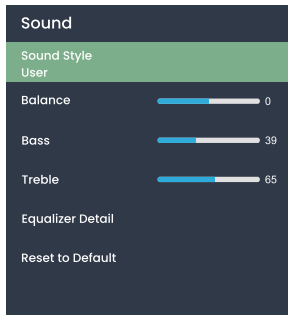

Sound Style	<b>User / Standard / Vivid / Sports / Movie / Music / News</b>	
Balance	-50-50	
Bass	0-100	
Treble	0-100	
Equalizer Detail	120Hz	-50-50
	500Hz	-50-50
	1.5KHz	-50-50
	5KHz	-50-50
	10KHz	-50-50
Reset to Default	Press to restore original sound setting.	



## WIFI CONNECTION & SCREEN MIRRORING

### WIFI CONNECTION

1. Go to (Homepage) > (Setup) > (WIFI Setting)
2. Turn the WIFI (ON) and search out the WIFI list by "Add WIFI"
3. Select your WIFI, then enter password to connect

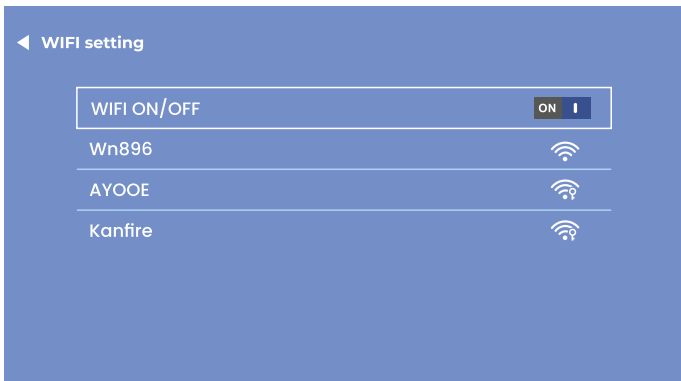

#### NOTE:

If you need screen mirroring, the speed of your home network is directly related to the smoothness of video play. Please make sure that the network is good to have a smoother playback.

## SCREEN MIRRORING

### IOS CAST (For IOS System)

1. Go to (Homepage) > (IOS CAST) to show the bellow page
2. On your iOS device open control center and tap Screen Mirroring
3. Looking for device that can be mirrored on
4. Select BirdCast-XXXX from the list to connect

**ROTACAST**

Make sure that your IOS device is connected to the same network as your projector

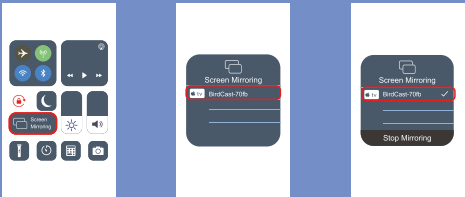

1. On your IOS device, open control Center and tap Screen Mirroring
2. Looking for devices that can be mirrored on
3. Select BirdCast-70fb from the list

Network error  BirdCast-70fb

#### NOTE:

Please make sure the projector and your IOS device has connected to the same Wifi .  
If there is no WIFI, please open a hotspot on your IOS device and connect the projector to it.

## DLNA (For iOS Device Only)

1. Make sure that you device is connected to the same network as your projector.
2. **Open your video player software**
3. Click the  icon and select the projector name BirdCast-XXX to connect

### Note:

1. The DLNA connection can be operated in any page of the projector.
2. After connected via DLNA, the phone can continue to use as normally, the projected video will keep playing while the mobile phone interface **will not be showed synchronously**.
3. The app needs to support screen-casting playback (some apps have restrictions on screen-casting).
4. Some streamig videos cannot be screen-cast due to copyright restrictions, which has nothing to do with the projector itself.

## MIRACAST (For Android System)

1. Go to [\(Homepage\)](#)-> [\(MIRACAST\)](#) to show the bellow page
2. On your Android device launch the Multi-screen/Wireless Display/Screen Mirroring/Smart View Function.
3. Looking for device that can be mirrored on
4. Select BirdCast-XXXX from the list to connect



The screenshot shows the ROTACAST app interface. At the top, the word "ROTACAST" is in a rounded rectangle. Below it, the text "Android Screen" is followed by "To Connect Android Mobile/Pad with Projector Based on WiFi-Display Technology". In the center, there is a dark blue rounded rectangle containing icons for a projector, a wireless signal, a tablet, and a smartphone. Below the icons, there are three numbered instructions: 1. On your android device, turn on WLAN (not necessary to connect to any Wi-Fi router) 2. Launch the Multi-screen / Wireless Display / Screen Mirroring / Smart View function 3. Select Android-70fb from the searching result list

### NOTE:

1. Please remember to open the WIFI function on your Android device, but not necessary to connect to any WIFI router.
2. When you disconnect Miracast, please manually reconnect the wifi in the settings, or wait 1-2 minutes to let it **automatically restore the connection**.

## WIRELESS CONNECTION SETTINGS

### A. Wireless Connecting

1. Go to (Homepage) > (Setup) > (Wireless connection Settings)
2. Turn the Wireless connection function ON and search for nearby Wireless connection devices
3. Choose correct Wireless connection device to connect

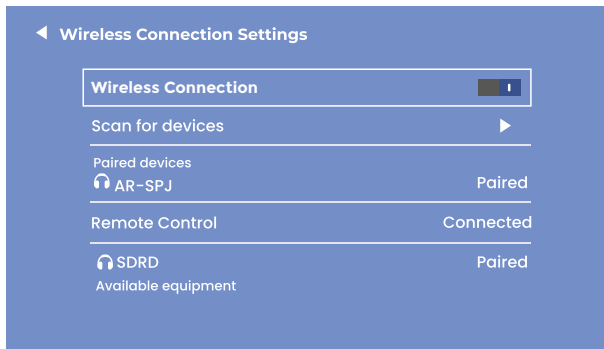

#### NOTE:

1. Wireless connection function is ONLY for audio transfer with audio devices, NOT support video sync with smartphones.
2. If you want to connect your headphone/ speaker with audio port, please disconnect the wireless connection audio device from the projector first.

## B. Wireless Connection Remote Control

On the first start-up of the projector, it will appear the following page to guide the Wireless connection remote control **connecting**.

Please press and hold the left & right buttons at the same time for a few seconds to establish connection. After connected, **the operation of the remote control will be more sensitive and the coverage will be wider.**

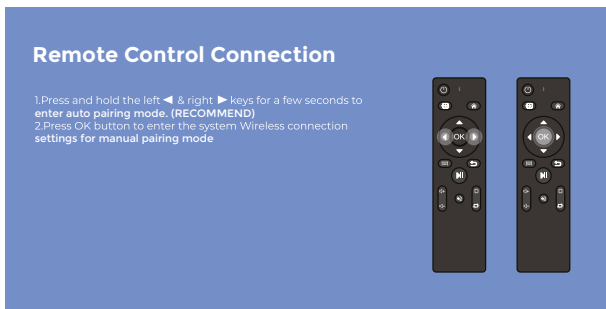

Two Working Mode of Remote:

1. **Common IR sensing:** need to point at the IR window of the projector and operate within the IR sensing range.
2. The Wireless connection control: rare in the market, once connect the remote control to the projector via Wireless connection, it's no longer limited by the sensing area, which is more sensitive and convenient to use. (Recommend)

### **Note:**

After the Wireless connection remote control connected, the other Wireless connection audio devices can also be connected without conflict.

Please keep the projector's Wireless connection ON to ensure the Wireless connection remote can connect and work as normal.

## PROJECTION SETTING

### A. Manual Keystone

1. Enter **Image Setting**
2. Choose **Keystone Advanced**, press Right button▶ or Left button◀to turn it into **Front Mode**
3. Choose **Manual Keystone**
4. Press Left button◀and Right button▶ to adjust the vertical keystone angle( $\pm 50^\circ$ ).

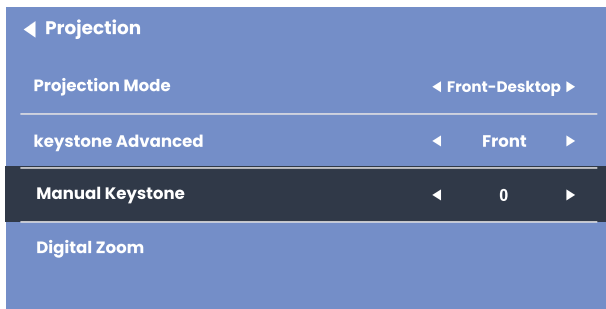

## B. 4 Point Keystone

1. Enter **Image Setting**
2. Choose **Keystone Advanced**, press **Right▶** or **Left◀** button to turn it into **Slide Mode**
3. Choose **4 Point Keystone**
4. Press Direction Buttons **↕** to adjust the angle, press OK button to jump to the next corner adjustment  
When the center circle for roundness image best proportion



"OK" Select

"↕" Adjust

"↶" Back

"☰" Reset

NOTE: If you want to return to the original settings, press the Menu **☰** to reset.

## C. Digital Zoom

1. Enter **(Image Setting)**
2. Choose **(Digital Zoom)**
3. Press Down button ▼ to Zoom out (100%-50%) and Up button ▲ to Zoom in(50%-100%).



" Adjust



" Back



" Reset

NOTE: If you want to return to the original settings, press the Menu  to reset.



## OTHER SETTING

### A. Boot Source Option: OFF/ HDMI 1/ HDMI 2/ AV

(The default setting is OFF, which can be modified as needed)

### B. Power On Option: Standby/ Direct

(The default setting is Standby. If you change it to Direct, please note that if the projector suddenly loses power while working, it need to wait for a while (10-20 seconds) and then connect the power. The projector will automatically restart without press "Power" button.)

### C. Language Settings

(The system provides 30 language options, you can choose it according to your requirement. )

### D. Scheduled Shutdown: 10 min/ 20 min/ 30 min/ 60 min/ 120min

(Set the automatic shutdown time according to your needs)

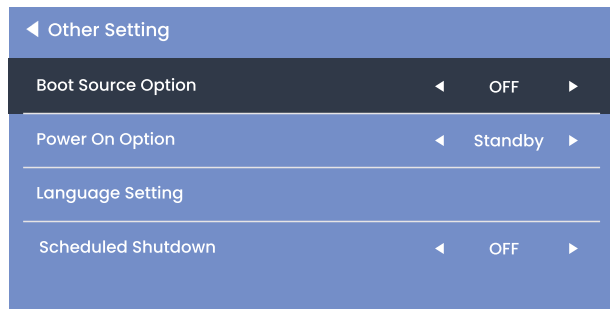

## SPECIFICATION

Display Technology	LCD	Light Source	LED
Resolution	1920*1080	Input Signal	HDMI / USB / AV
Aspect Ratio	16:9 / 4:3	Focus	Manual
Keystone	4-Point Keystone Manual Keystone	Speaker	5W*2
Bluetooth	Version 5.0	Power Supply	INPUT:100-240V OUTPUT:DC 36V 5A
Total power	150W	Photo Format Supported	gif. svg. bmp. jpeg. png. jpg
Audio Format Supported	aac. wav. amr. flac. mp2. mp3. ogg	Video Format Supported	3gp. avi. v. m4v. mkv. mov. mp4. mpg. rmvb. swf
Ports	HDMI1/ HDMI2/ USB1/ USB2/ AV/ 3.5mm Audio	Installation Type	Table Mount/ Ceiling Mount
Unit Dimension	278*240*108mm (10.9*9.4*4.2inch)	Unit Net Weight	2.6kg / 5.7lb

## TROUBLE SHOOTING



Remote control not work?

- Make sure the batteries are effective and installed in the correct way.
- Make sure the remote control has connected Bluetooth.

A



Blurry Image?

- Adjust focus gear/keystone to get the best image.
- The quality of the projection screen will also affect the image quality. Recommended to use it on a white wall or a better quality screen. Not suggest to use it on a thin white gauze screen, which will reduce the image quality.

A



No Sound?

- Turn Dolby audio off in your device. (such as TV stick, Roku, Laptop etc.)
- The mute button on the remote was be pressed accidentally.

A



Automatic shut-down?

- Overheating protection. Please use in a ventilated environment.
- It is recommended to unplug the power supply after use to prolong the service life.

A



Upside down image?

- Press "Flip" button on the remote control.
- enter "Projection Settings" to change the Projection Mode.

A



The content from HULU, Netflix, and similar services can not be mirrored or cast?

--Due to the copyright restriction from Hulu, Netflix, and similar services, the contents can't be mirrored or cast.  
--If needed to play these videos, please prepare a TV stick, Roku or Chromecast (not included).

A



TV stick can't fully plug into HDMI port, not work?

--Generally the TV stick will come with a extend cable in the package, please connect it via the extend cable.

A



Black spot on the screen?

--Wipe the lens with dry and clean cloth to remove dust on the lens.  
--Slap the top, left, and right sides of the machine several times with a little force to remove the dust inside the lens.

A



Missing accessories?

--If the device is damaged or any accessories missing, please contact our after-sales department for help.

A

## Warranty policy

This product complies with the warranty law in force in the country of purchase. When **you have a problem that you can not solve, you must access the web [www.prixton.com](http://www.prixton.com)** and click on the contact option to send us your assistance form.

These technical and electrical specifications are those of typical units and may be **changed without prior notice in order to provide improved equipment.**

## Simplified EU Declaration Of Conformity

We, La Trastienda Digital located in Avenida Cervantes 49, módulo 25, Basauri 48970, Bizkaia hereby declare that the following goods, imported and selling at European market:

<b>BRAND</b>	<b>MODEL NAME</b>	<b>DESCRIPTION</b>	<b>CATEGORY</b>
Prixton	KUBRICK	Projector	Image

Are in compliance with the EC Council Directive of 2014/53/EU (EM DIRECTIVE) and harmonized standards and with the board of the 16th of April 2014.

The complete text of the UE Declaration of conformity is available anytime at this website **address:**  
**[www.prixton.com](http://www.prixton.com)**

LA TRASTIENDA DIGITAL

## CONTENU DE L'EMBALLAGE

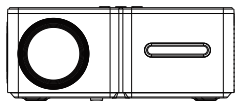

Projecteur Miró



Télécommande

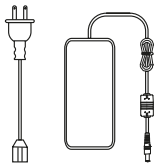

Power Cable



Mode d'emploi

## AVERTISSEMENT

### Recommandé

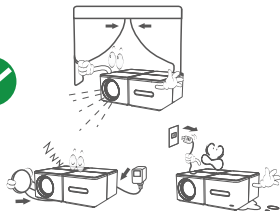

### NON recommandé



## FONCTION VUE D'ENSEMBLE

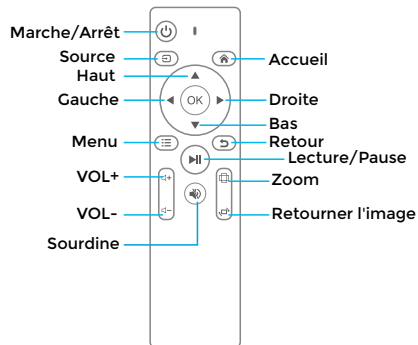
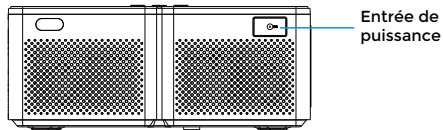
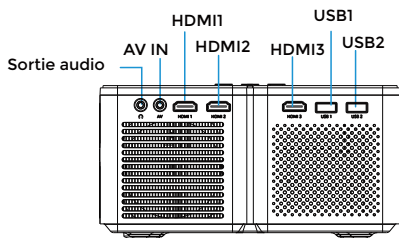
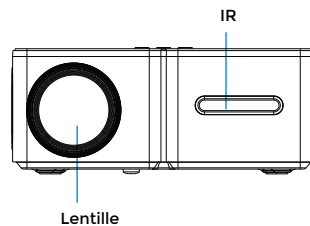
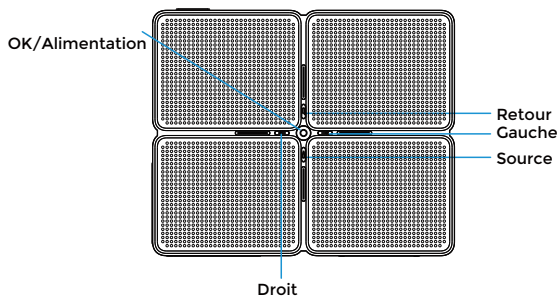

## DÉMARRAGE RAPIDE

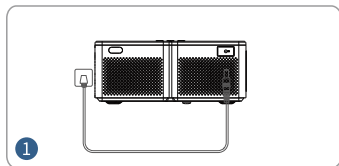

1 Branchez le câble d'alimentation dans une prise de courant

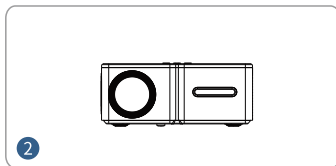

2 Retirez le couvercle de l'objectif avant utilisation.

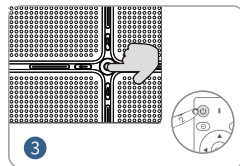

3 Appuyez sur le bouton marche/arrêt pour allumer le projecteur

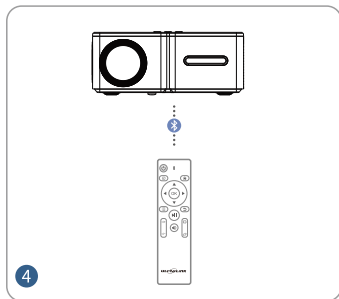

4 Connectez votre télécommande au projecteur via la Connexion sans fil

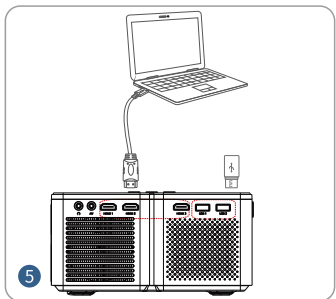

5 Connectez votre appareil au projecteur correctement

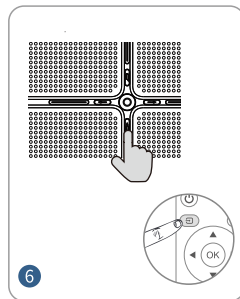

6 Appuyez sur la touche Source et sélectionnez la source d'entrée correcte

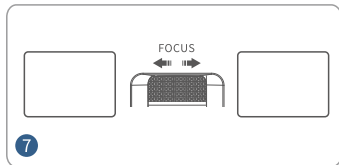

7 Réglez la molette de mise au point pour obtenir le meilleur

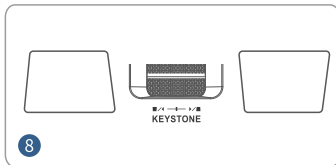

8 Ajustez la distorsion trapézoïdale pour obtenir la bonne taille

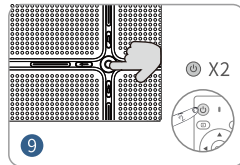

9 Appuyez deux fois sur le bouton marche/arrêt pour éteindre le rendement de l'image



## DISTANCE et TAILLE DE LA PROJECTION

Un environnement sombre combiné à un bon écran de projection amélioreront la clarté des images projetées.

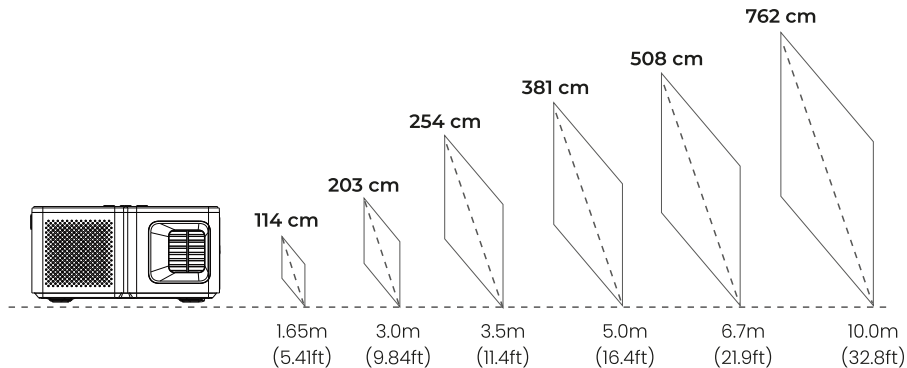

## MODE DE PROJECTION

Si vous souhaitez suspendre le projecteur au plafond, vous aurez besoin d'un support de projecteur.

Si vous souhaitez utiliser un autre mode de projection, sélectionnez le mode correspondant dans la page de configuration.



AVANT/TABLE

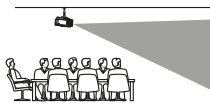

AVANT/PLAFOND



ARRIÈRE/TABLE

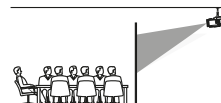

ARRIÈRE/PLAFOND

## ENTRÉE SOURCE

Appuyez sur le bouton (Source ) du projecteur ou de la télécommande pour accéder à l'interface de la source d'entrée.

### A. Connexion HDMI

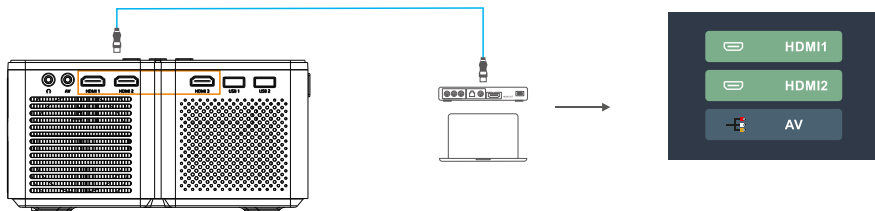

### B. Connexion AV

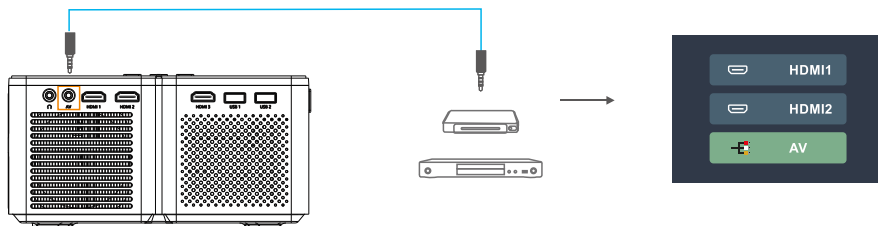

### C. Connexion USB

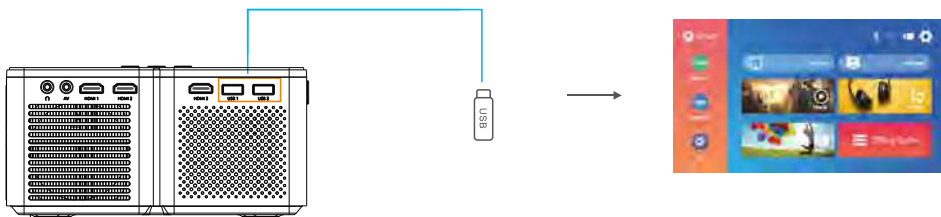

## PARAMÉTRAGE DU LECTEUR MULTIMÉDIA

Lorsque vous utilisez le lecteur multimédia, choisissez d'abord l'entrée correcte sur la page d'accueil. Si vous choisissez l'entrée Film, le projecteur détectera UNIQUEMENT les fichiers de format vidéo de la clé USB. (L'interface des trois autres et ainsi de suite)

### A. Réglages du lecteur de films



Appuyez sur le bouton  
**OK**

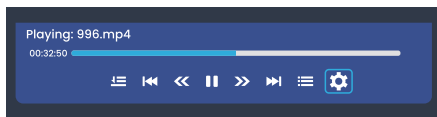

- |                    |                       |              |
|--------------------|-----------------------|--------------|
| : Mode lecture     | : Précédent           | : Rembobiner |
| : Lecture          | : Avance rapide       | : Suivant    |
| : Liste de lecture | : Réglages de lecture |              |

### B. Paramètres du lecteur de musique

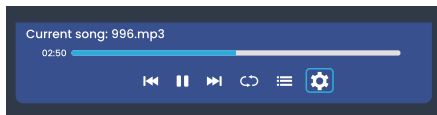

- |                |                    |                   |
|----------------|--------------------|-------------------|
| : Précédent    | : Lecture          | : Suivant         |
| : Mode lecture | : Liste de lecture | : Réglages du son |

### C. Paramètres du lecteur d'images



Appuyez sur le bouton  
**OK**

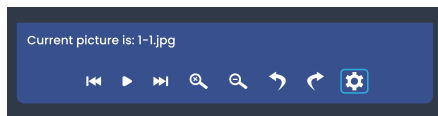

: Précédent



: Lecture



: Suivant



: Zoom arrière



: Augmenter



: Pivoter à gauche



: Pivoter à droite



: Réglages de l'image

### D. Paramètres de la suite Office



: Connexion à un compte



: Partager



: Configuration de fichiers

## RÉGLAGES DE L'IMAGE ET DU SON

En mode HDMI ou AV, appuyez sur la touche Menu  pour accéder aux réglages de l'image et du son.

### A. Réglages de l'image :

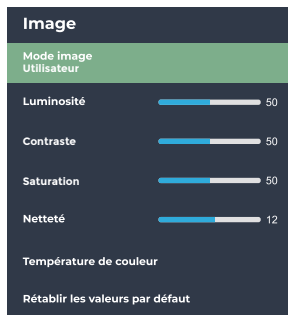

Mode image	Utilisateur / Standard / Dynamique / Modéré	
Luminosité	0~100	
Contraste	0~100	
Saturation	0~100	
Netteté	0~20	
Température de couleur	Utilisateur/ Froid/ Standard/ Chaud	Gain de rouge : -100~100
		Gain de vert : -100~100
		Gain de bleu : -100~100
Rétablir les valeurs par défaut	Appuyez sur cette touche pour rétablir le réglage d'origine de l'image.	

### B. Réglages du son :

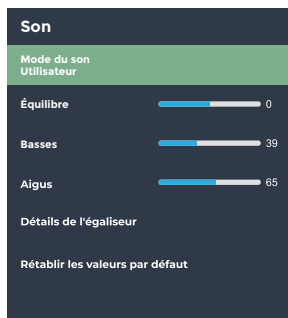

Mode du son	Utilisateur/ Standard/ Film/ Musique/ Sports	
Équilibre	-50~50	
Basses	0~100	
Aigus	0~100	
Détails de l'égaliseur	120Hz	-50~50
	500Hz	-50~50
	1.5KHz	-50~50
	5KHz	-50~50
	10KHz	-50~50
Rétablir les valeurs par défaut	Appuyez sur cette touche pour rétablir le réglage sonore d'origine.	

## CONNEXION WI-FI ET PARTAGE D'ÉCRAN

### CONNEXION WI-FI

1. Allez à la [page d'accueil](#) > [Paramètres](#) > [Paramètres Wi-Fi](#)
2. Allumez le [Wi-Fi](#) et cherchez la liste des réseaux Wi-Fi au moyen de l'option « Ajouter Wi-Fi »
3. Choisissez votre réseau Wi-Fi, puis entrez le mot de passe pour vous connecter

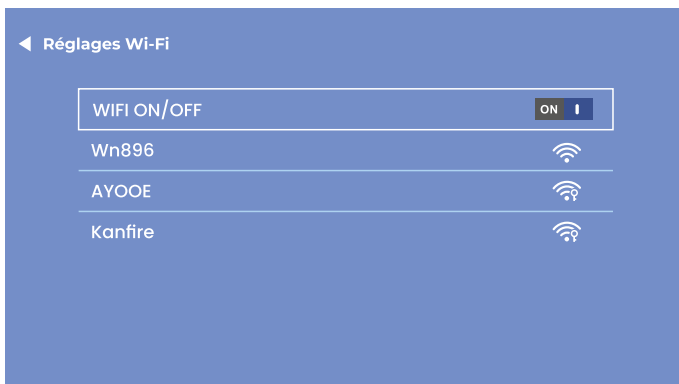

#### NOTE :

Si vous voulez partager l'écran, la vitesse de votre réseau domestique est directement liée à la fluidité de la lecture vidéo. Assurez-vous que le réseau est bon et que le projecteur n'est pas éloigné du routeur afin d'obtenir une lecture plus fluide.

## PARTAGE D'ÉCRAN

### IOS CAST (Pour système IOS)

1. Allez à la (page d'accueil) > (IOS CAST) pour afficher la page suivante
2. Sur votre appareil iOS, ouvrez le centre de contrôle et appuyez sur Partage d'écran
3. Recherche d'un dispositif pouvant être partagé
4. Sélectionnez BirdCast-XXXX dans la liste pour vous connecter

**ROTACAST**

Assurez-vous que votre appareil iOS est connecté au même réseau que votre projecteur



1. Sur votre appareil iOS, ouvrez le Centre de contrôle et appuyez sur Partage d'écran
2. Recherche de dispositifs pouvant être partagés dans
3. Sélectionnez BirdCast-70fb dans la liste.

 Network error  BirdCast-70fb

#### NOTE :

Assurez-vous que le projecteur et votre appareil iOS sont connectés au même réseau Wi-Fi. Si l'y a pas de Wi-Fi, ouvrez un hotspot à l'aide de votre appareil iOS et connectez-y le projecteur.

## DLNA (Pour les appareils iOS)

1. Assurez-vous que votre appareil est connecté au même réseau que le projecteur.
2. Ouvrez votre logiciel de lecture vidéo
3. Cliquez sur l'icône  et sélectionnez le nom du projecteur BirdCast-XXXX pour connecter les appareils.

NOTE :

1. La connexion DLNA peut fonctionner sur n'importe quelle page du projecteur.
2. Une fois connecté via DLNA, le téléphone peut être utilisé normalement. La vidéo projetée continuera à être lue, tandis que l'interface du téléphone portable ne sera pas affichée de manière synchrone.
3. L'application doit prendre en charge lecture de vidéographie ou de screencast (certaines applications ont des restrictions sur les screencasts).
4. Certaines vidéos en streaming ne peuvent pas être projetées en raison de restrictions liées aux droits d'auteur, ce qui n'a rien à voir avec le projecteur.

## MIRACAST (Pour les systèmes Android)

1. Allez sur la [page d'accueil](#) > [MIRACAST](#) pour afficher la page suivante
2. Sur votre appareil Android, lancez la fonction Multiécran/ Visualisation sans fil/ Partage d'écran/ Smart View.
3. Recherche d'un dispositif pouvant être partagé
4. Sélectionnez BirdCast-XXXX dans la liste pour connecter les appareils.

### ROTACAST

#### Écran Android

Pour connecter un téléphone portable/une tablette Android à un projecteur basé sur la technologie Wi-Fi-Display



1. Sur votre appareil Android, activez le WLAN (il n'est pas nécessaire de se connecter à un routeur Wi-Fi)
2. Lancez la fonction Multiécran / Visualisation sans fil / Partage d'écran / Smart View
3. Sélectionnez Android-70fb dans la liste des résultats de la recherche

NOTE :

1. N'oubliez pas d'activer la fonction Wi-Fi sur votre appareil Android.
2. Lorsque vous déconnectez Miracast, reconnectez-le manuellement dans les paramètres ou attendez 1 à 2 minutes pour que la connexion se rétablisse automatiquement.



## CONNEXION AUDIO SANS FIL

### A. Connexion sans fil

1. Aller à la [page d'accueil](#) > [Paramètres](#) > [Paramètres sans fil](#)
2. Activez la fonction de connexion sans fil et recherchez les appareils sans fil à proximité
3. Choisissez l'appareil sans fil correspondant pour le connecter



#### NOTE :

1. La fonction sans fil est UNIQUEMENT destinée au transfert audio avec des appareils audio. Elle NE prend PAS en charge la synchronisation vidéo avec les smartphones. 2. Si vous souhaitez connecter votre casque/haut-parleur au moyen du port audio, déconnectez d'abord l'appareil audio sans fil du projecteur.

## B. Télécommande pour la connexion sans fil

Lors du premier démarrage du projecteur, la page suivante s'affiche pour guider la connexion de la télécommande sans fil. Appuyez simultanément sur les touches gauche et droite pendant quelques secondes pour établir la connexion. Une fois connecté, le fonctionnement de la télécommande sera plus sensible et la couverture sera plus large.



### Deux modes de télécommande :

1. Détection infrarouge classique : la télécommande doit être orientée vers le capteur infrarouge du projecteur et fonctionner dans la plage de détection infrarouge.
2. Télécommande par Bluetooth : une fois la télécommande connectée au projecteur via Bluetooth, elle n'est plus limitée par la zone de détection, ce qui rend la rend plus sensible et pratique.

### Note :

Une fois la télécommande Bluetooth connectée, d'autres appareils audio Bluetooth peuvent également être connectés sans problèmes.

Veillez à ce que la fonction Bluetooth du projecteur soit activée pour que la télécommande Bluetooth puisse se connecter et fonctionner normalement.

## PARAMÈTRES DE PROJECTION

### A. Réglage simple (Kestone manuel)

1. Choisissez l'option **Ajustements** de l'image
2. Choisissez **Clé avancée**, appuyez sur la touche droite ► ou gauche ◀ pour passer en **Mode frontal**
3. Choisissez **Keystone manuel**
4. Appuyez sur les touches gauche ◀ et droite ► pour régler l'angle trapézoïdal vertical ( $\pm 50^\circ$ ).

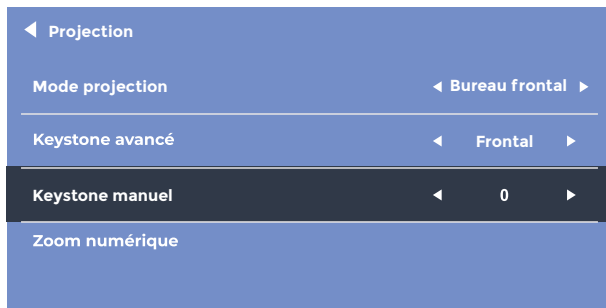

## B. Réglage avancé (Keystone avancé)

Ce paramètre vous permettra de régler indépendamment chaque coin de l'image projetée sans avoir à déplacer le projecteur.

**Cette fonction permet d'effectuer des projections latérales.**

1. Choisissez l'option (Ajustements de l'image)
2. Choisissez l'option (Keystone avancé) appuyez sur la touche droite ► ou gauche ◀ pour passer en (Mode diapositive)
3. Choisissez (Keystone à 4 points)
4. Appuyez sur les touches ◀▶ directionnelles pour régler l'angle, puis appuyez sur la touche OK pour passer au réglage de l'angle suivant.

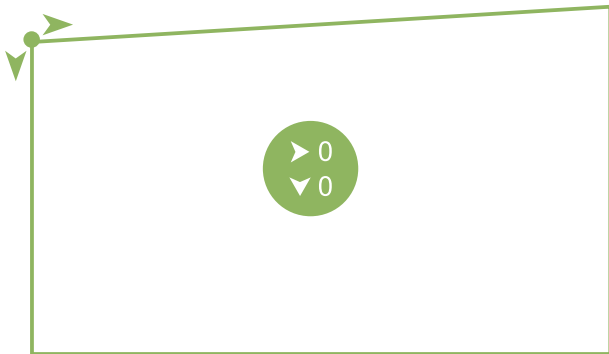

"OK" Sélectionnez" ◀▶ " Ajuster " ◀ " Retour " ≡ " Redémarrer

NOTE : Si vous souhaitez revenir aux ajustements d'origine, appuyez sur Menu ≡ Réinitialiser.

## C. Zoom numérique

1. Choisissez l'option (Ajustements de l'image)
2. Choisissez (Zoom numérique)
3. Appuyez sur le bouton Bas ▼ pour éloigner l'image (100%-50%) et sur le bouton Haut ▲ pour l'agrandir (50 %-100 %).



" Ajuster



" Retour



" Réinitialiser

NOTE : Si vous souhaitez revenir aux ajustements d'origine, appuyez sur Menu  Réinitialiser.

## Politique de garantie

Ce produit est conforme à la loi sur la garantie en vigueur dans le pays d'achat. Lorsque vous avez un problème que vous ne pouvez pas résoudre, vous devez accéder au site [www.prixton.com](http://www.prixton.com) et cliquer sur l'option de contact pour nous envoyer votre formulaire d'assistance.

Les caractéristiques techniques et électriques ici correspondent à des unités spécifiques et pourraient être modifiées sans préavis afin d'améliorer le matériel.

## Déclaration De Conformité Simplifiée

La Trastienda Digital SL, en tant que propriétaire de la marque Prixton, située dans Avenida Cervantes 49, módulo 25, Basauri 48970, Bizkaia, déclare que le type d'équipement radioélectrique indiqué ci-dessous est le suivant :

MARQUE	MODÈLE	DESCRIPTION	CATÉGORIE
Prixton	KUBRICK	Projector	Image

Est conforme à la directive 2014/53/UE du Parlement européen et du Conseil du 16 avril 2014.

Le texte intégral de la déclaration de conformité de l'UE est disponible sur Internet à l'adresse suivante :  
[www.prixton.com](http://www.prixton.com)

LA TRASTIENDA DIGITAL

**ELENCO DEGLI IMBALLAGGI**

Proiettore Miró



Telecomando

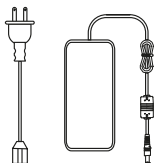

Power Cable



Manuale d'uso

**AVVISO**

Consigliato

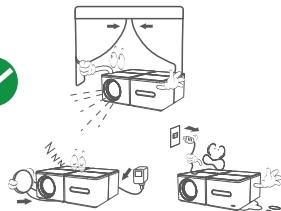

NON consigliato



## FUNZIONE PANORAMICA

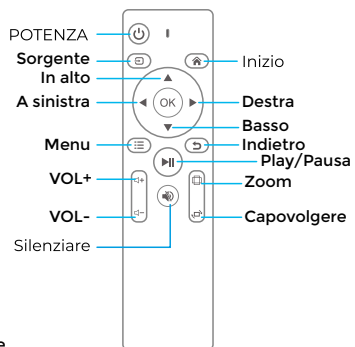
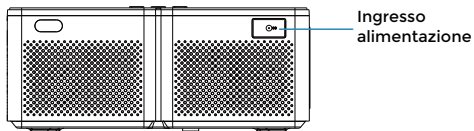
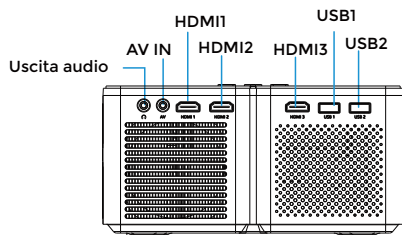
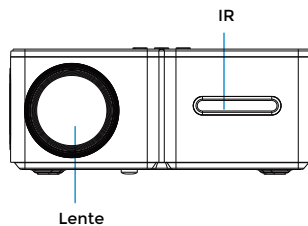
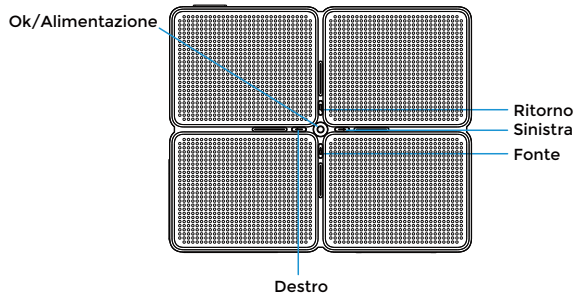



## AVVIO RAPIDO

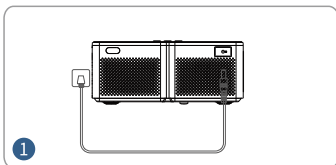

1 Collegare il cavo di alimentazione alla presa di corrente.

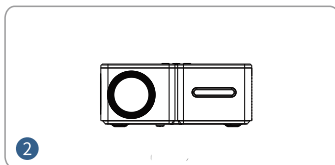

2 Rimuovere il copriobiettivo prima dell'uso.

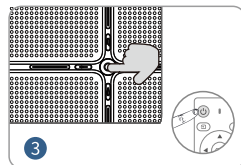

3 Premere il tasto di accensione per accendere il proiettore

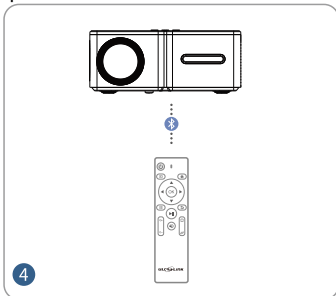

4 Collegare il telecomando al proiettore tramite connessione wireless.

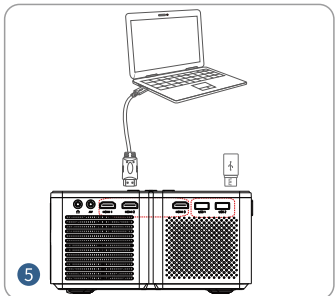

5 Collegare correttamente il dispositivo al proiettore.

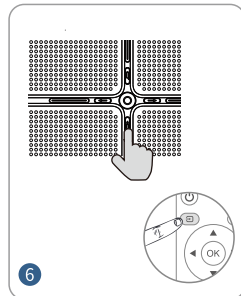

6 Premere il pulsante Sorgente e selezionare la sorgente di ingresso corretta.

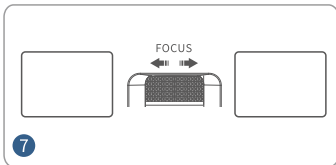

7 Regolare l'anello di messa a fuoco per migliorare l'immagine

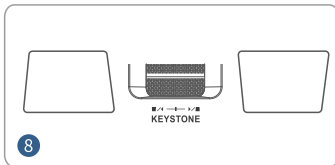

8 Regolare la distorsione trapezoidale per ottenere le dimensioni corrette

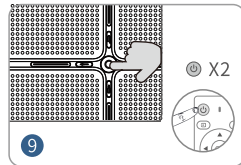

9 Premere due volte il tasto di accensione per spegnere il resa dell'immagine.

## DISTANZA e DIMENSIONE DELLA PROIEZIONE

Un ambiente buio abbinato a un buon schermo di proiezione migliorerà la nitidezza delle immagini proiettate.

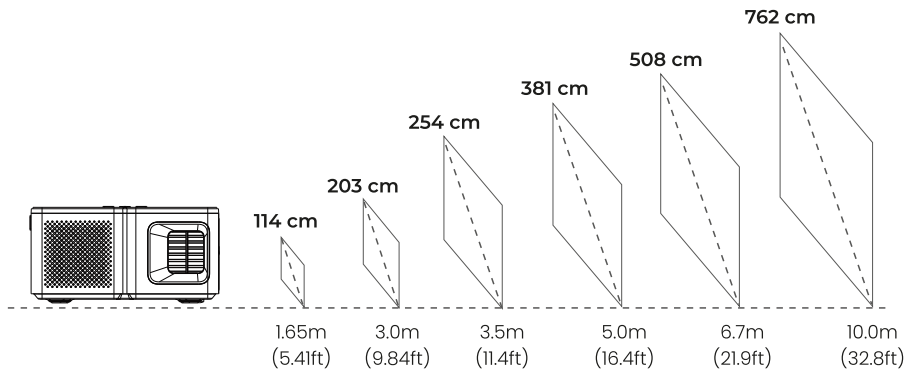

## MODALITÀ DI PROIEZIONE

Se si vuole appendere il proiettore al soffitto, è necessario un supporto specifico per proiettore.

Per proiettare in una modalità diversa, selezionare la modalità corrispondente nella pagina di configurazione.



TAVOLO  
DAVANTI

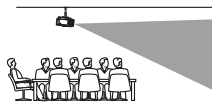

SOFFITTO  
DAVANTI

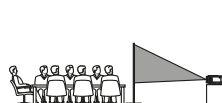

TAVOLO  
DIETRO

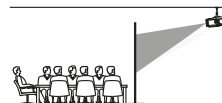

SOFFITTO  
DIETRO

## INGRESSO SORGENTE

Premere ( Sorgente  ) sul proiettore o sul telecomando per accedere all'interfaccia Sorgente di ingresso.

### A. Collegamento HDMI

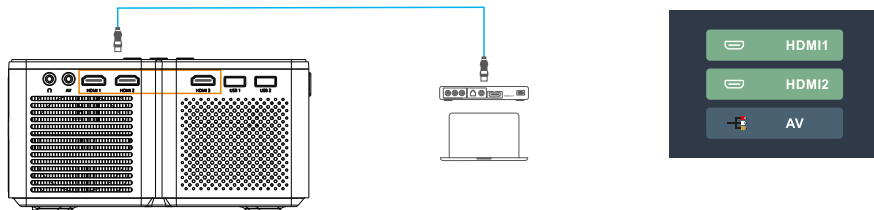

### B. Collegamento AV

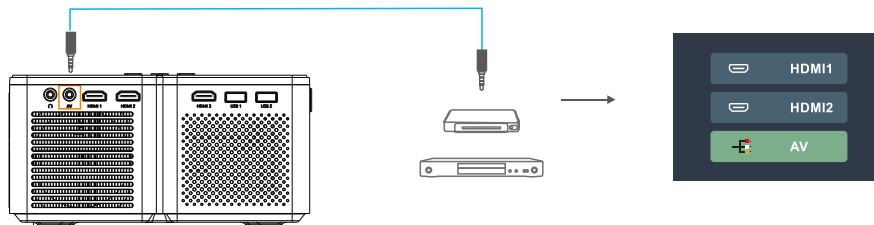

### C. Collegamento USB

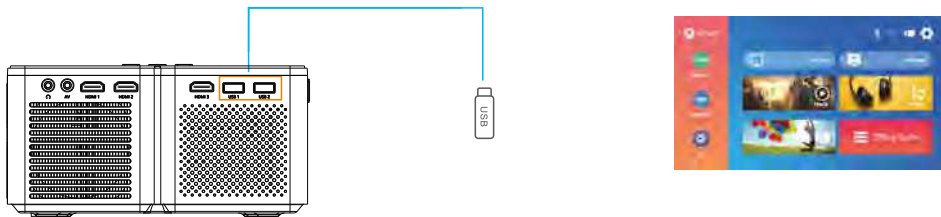

## IMPOSTAZIONI DEL LETTORE MULTIMEDIALE







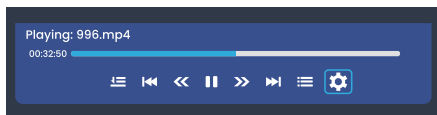

Quando si utilizza il lettore multimediale, scegliere innanzitutto la voce corretta nella pagina iniziale. Se si inserisce Film, il programma rileverà SOLO i file in formato video presenti sulla chiavetta USB. (L'interfaccia degli altri tre è così via)

### A. Impostazioni del lettore di filmati









Premere il tasto OK

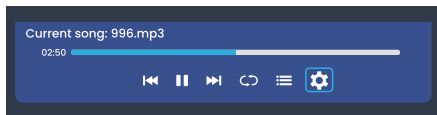
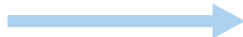

-  : Modalità di riproduzione
-  : Precedente
-  : Riavvolgere
-  : Play
-  : Avanti veloce
-  : Successivo
-  : Playlist
-  : Impostazioni di riproduzione

### B. Impostazioni del lettore musicale



-  : Precedente
-  : Play
-  : Successivo
-  : Modalità di riproduzione
-  : Playlist
-  : Impostazioni audio

### C. Impostazioni del lettore di immagini



Premere il tasto **OK**

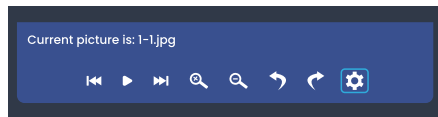

: Precedente



: Play



: Suc



: Ridurre



: Ingrandire



: Girare a sinistra



: Ruota a destra



: Impostazioni dell'immagine

### D. Impostazioni del pacchetto Office



: Accesso all'account



: Condividi



: Configurazione dei file

## IMPOSTAZIONI DELL'IMMAGINE E DEL SUONO

In modalità HDMI o AV, premere il tasto Menu  per accedere alle impostazioni dell'immagine e del suono.

### A. Impostazioni dell'immagine:

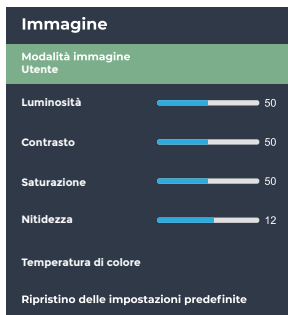

Modalità immagine	Utente / Standard / Dinamico / Moderato	
Luminosità	0-100	
Contrasto	0-100	
Saturazione	0-100	
Nitidezza	0-20	
Temperatura di colore	Utente/ Freddo/ Standard/ Caldo	Aumenta rosso : -100-100
		Aumenta verde : -100-100
		Aumenta blu : -100-100
Ripristino delle impostazioni predefinite	Premere per ripristinare l'impostazione originale dell'immagine.	

### B. Impostazioni audio:

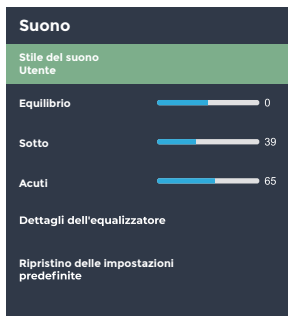

Stile del suono	Utente/ Standard/ Film/ Musica/ Sport	
Equilibrio	-50-50	
Sotto	0-100	
Acuti	0-100	
Dettagli dell'equalizzatore	120Hz	-50-50
	500Hz	-50-50
	1.5KHz	-50-50
	5KHz	-50-50
	10KHz	-50-50
Ripristino delle impostazioni predefinite	Premere per ripristinare l'impostazione audio originale.	

## CONNESSIONE WIFI E SCREEN MIRRORING

### CONNESSIONE WIFI

1. Andare alla [pagina iniziale](#) > [Impostazioni](#) > [Impostazioni WIFI](#)
2. Accendere il(WIFI)e cercare l'elenco WIFI tramite "Aggiungi WIFI"
3. Scegliere il WIFI, quindi inserire la password per la connessione

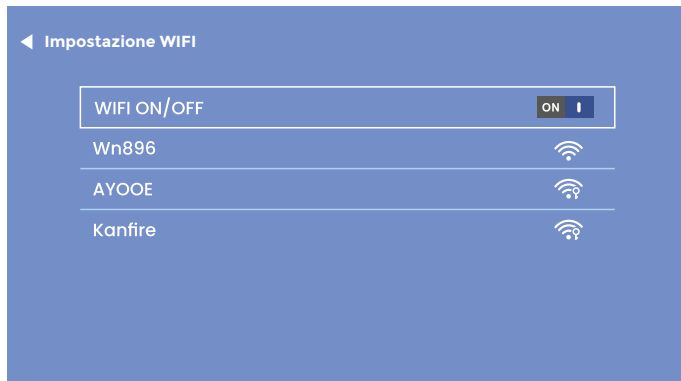

#### NOTA:

Se è necessario duplicare lo schermo, la velocità della rete domestica è direttamente correlata alla fluidità della riproduzione video. Per una riproduzione più fluida, assicurarsi che la connessione di rete sia buona e non lontana dal **router**.

## SCHERMO DUPLICATO

### IOS CAST (Per IOS System)

1. Vai alla pagina iniziale > IOS CAST per visualizzare la seguente pagina
2. **Sul dispositivo iOS, aprire il Centro di controllo e toccare Specchio schermo**
3. Alla ricerca di un dispositivo che possa essere riflesso in
4. Selezionare BirdCast-XXXX dall'elenco per collegarsi

**ROTACAST**

Assicurarsi che il dispositivo iOS sia collegato alla stessa rete del proiettore



The first screenshot shows the iPhone Control Center with the 'Screen Mirroring' icon highlighted. The second screenshot shows the 'Screen Mirroring' menu with 'BirdCast-70fb' selected. The third screenshot shows the 'Screen Mirroring' menu with 'BirdCast-70fb' checked and a confirmation checkmark.

1. Sul dispositivo iOS, aprire il Centro di controllo e toccare Duplica schermo
2. Ricerca i dispositivi che possano essere riflessi in
3. Selezionare BirdCast-70fb dall'elenco

Network error  BirdCast-70fb

#### NOTA:

Assicurarsi che il proiettore e il dispositivo iOS siano collegati alla stessa rete Wifi.  
In assenza del WIFI, aprire un hotspot sul dispositivo iOS e collegarvi il proiettore.



## DLNA (Per dispositivi iOS)

1. Assicurarsi che il dispositivo sia collegato alla stessa rete del proiettore.
2. Aprire il software di riproduzione video
3. Cliccare sull'icona  e selezionare il nome del proiettore BirdCast-XXXX da collegare

NOTA:

1. La connessione DLNA può funzionare su qualsiasi pagina del proiettore.
2. Dopo la connessione via DLNA, il telefono può essere utilizzato normalmente; il video proiettato continuerà a essere riprodotto mentre l'interfaccia del telefono cellulare non verrà visualizzata in modo sincrono.
3. L'applicazione deve supportare la videografia o la riproduzione di screencast (alcune applicazioni hanno restrizioni per gli **screencast**).
4. Alcuni video in streaming non possono essere proiettati sullo schermo a causa di restrizioni di copyright, che non hanno nulla **a che vedere con il proiettore stesso**.

## MIRACAST (Per sistemi Android)

1. Vai alla [homepage](#) > [MIRACAST](#) per visualizzare la pagina seguente
2. Sul dispositivo Android, avviare la funzione Multi Screen/ Wireless Viewer/ Mirror Screen/ Smart View.
3. Alla ricerca di un dispositivo che possa essere riflesso in
4. Selezionare BirdCast-XXXX dall'elenco per collegarsi

### ROTACAST

#### Schermo Android

Per collegare un telefono cellulare/tablet Android con un proiettore basato sulla tecnologia WiFi-Display



1. Sul dispositivo Android, attivare la WLAN (non è necessario collegarsi a un router Wi-Fi)
2. Avviare la funzione Multi Screen / Wireless Display / Mirror Screen / Smart View
3. Selezionare Android-70fb dall'elenco dei risultati della ricerca

NOTA:

1. Ricordarsi di aprire la funzione WIFI sul dispositivo Android.
2. Quando si disconnette Miracast, riconnettersi manualmente nelle impostazioni o attendere 1-2 minuti affinché la **connessione venga ristabilita automaticamente**.

## CONNESSIONE AUDIO WIRELESS

### A. Connessione wireless

1. Vai alla pagina iniziale > Impostazioni > Impostazioni wireless
2. Attivare la funzione di connessione wireless e scansionare i dispositivi wireless nelle vicinanze
3. Scegliere il **dispositivo wireless giusto a cui collegarsi**



#### NOTA:

1. La funzione wireless serve SOLO per il trasferimento audio con i dispositivi audio. NON supporta la sincronizzazione **video con gli smartphone**.
2. Se si desidera collegare le cuffie/altoparlanti con la porta audio, scollegare prima il dispositivo audio wireless dal **proiettore**.

## B. Telecomando per connessione wireless

Al primo avvio del proiettore, appare la seguente pagina per guidare il collegamento del telecomando senza fili. Tenere premuti contemporaneamente i pulsanti sinistro e destro per alcuni secondi per stabilire la connessione. Una volta collegato, il funzionamento del telecomando sarà più sensibile e la copertura sarà più ampia.



### Due modalità di telecomando:

1. Rilevamento a infrarossi comune: deve essere rivolto verso la finestra a infrarossi del proiettore e operare entro il campo di rilevamento a infrarossi. 2. Telecomando Bluetooth: una volta collegato al proiettore tramite Bluetooth, il telecomando non è più **limitato dall'area di rilevamento, risultando più sensibile e comodo da usare.**

### Nota:

Una volta collegato il telecomando Bluetooth, è possibile collegare senza problemi anche altri dispositivi audio Bluetooth. Tenere attivato il Bluetooth del proiettore per garantire che il telecomando Bluetooth possa collegarsi e funzionare normalmente.

## IMPOSTAZIONI DI PROIEZIONE

### A. Regolazione singola (Keystone manuale)

1. Inserire la regolazione (dell'immagine)
2. Scegliere il tasto (Advanced), premere il tasto destro ► o sinistro ◀ per convertire la (modalità Frontale)
3. Scegliere la (distorsione trapezoidale manuale)
4. Premere i pulsanti Sinistra ◀ e Destra ► per regolare l'angolo trapezoidale verticale ( $\pm 50^\circ$ ).



## B. Regolazione avanzata (Advanced Keystone)

Questa impostazione consente di regolare in modo indipendente ogni angolo dell'immagine proiettata senza dover spostare il proiettore. Con questa funzione è possibile proiettare lateralmente.

1. Inserire le **impostazioni dell'immagine**

2. Scegliere **Advanced Keystone**, premere il pulsante Destra ► o Sinistra ◀ per convertire in **modalità Diapositiva**

3. Scegliere **Keystone da 4 punti**

4. Premere i pulsanti di direzione ◀▶ per regolare l'angolo, premere il pulsante OK per passare all'impostazione dell'angolo successivo.

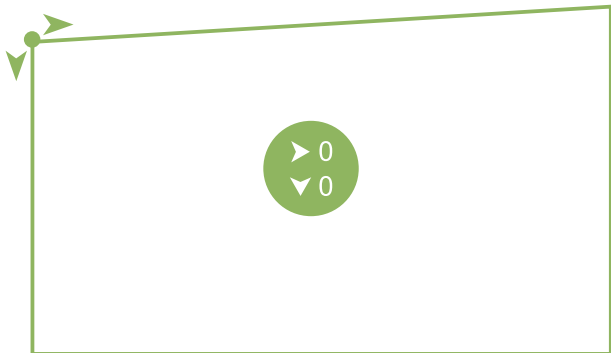

“OK” Selezionare “◀▶” Regolare “◀” Indietro “☰” Riavvio

NOTA: Per tornare alle impostazioni originali, premere Menu ☰ **Ripristina**.

## C. Zoom digitale

1. Inserire le impostazioni dell'immagine
2. Scegliere **Zoom digitale**
3. Premere il pulsante Giù ▼ per ridurre lo zoom (100%-50%) e il pulsante Su ▲ per aumentarlo (50%-100%).



" " Regola



" " Indietro



" " Azzeramento

NOTA: Per tornare alle impostazioni originali, premere Menu ≡ **Ripristina**.

## Politica di garanzia

Questo prodotto è conforme alla legge di garanzia vigente nel suo paese di acquisto.

**Quando hai un problema che non puoi risolvere, devi accedere al sito [www.prixton.com](http://www.prixton.com) e fare clic sull'opzione di contatto per inviarti il tuo modulo di assistenza.**

**Le caratteristiche tecniche ed elettriche qui riportate corrispondono alle unità tipiche e possono essere modificate senza preavviso per migliorare le qualità del dispositivo.**

## Dichiarazione Di Conformità Ue Semplificata

Con la presente, La Trastienda Digital SL come proprietaria del marchio commerciale Prixton, situata presso Avenida Cervantes 49, módulo 25, Basauri 48970, Bizkaia, dichiara **che il tipo di apparecchiatura radioelettrica che si mostra qui di seguito:**

MARCA	MODELLO	DESCRIZIONE	CATEGORIA
Prixton	KUBRICK	Projector	Image

È conforme alla Direttiva 2014/53/UE del Parlamento Europeo e della commissione del 16 aprile 2014.

Il testo completo della dichiarazione di conformità UE è disponibile a questo indirizzo web: [www.prixton.com](http://www.prixton.com)

LA TRASTIENDA DIGITAL

## ELENCO DEGLI IMBALLAGGI

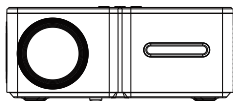

Proiettore Miró



Fernbedienung

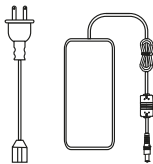

Power Cable



Bedienungsanleitung

## HINWEIS

Empfohlen

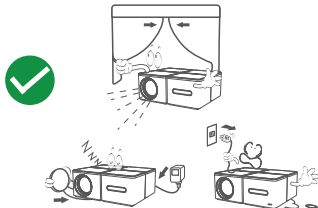

NICHT empfohlen





## FUNKTION ÜBERSICHT

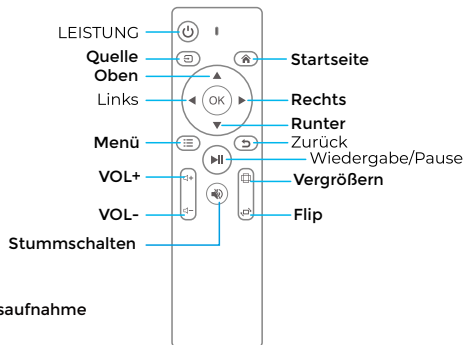
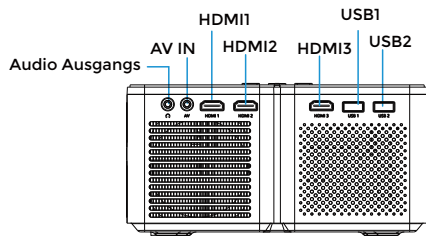
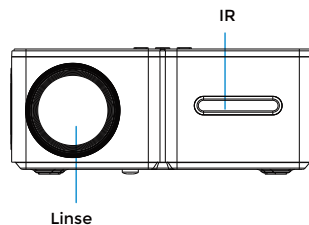
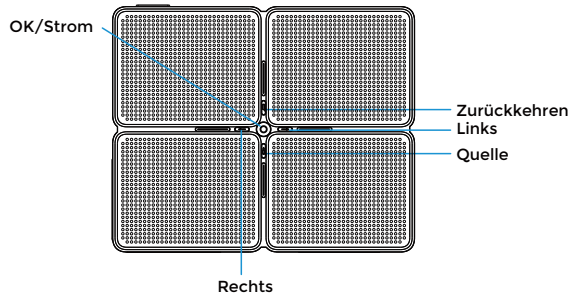

## AVVIO RAPIDO

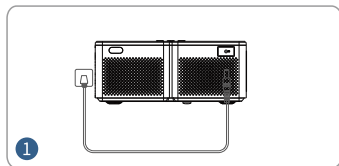

Stecken Sie das Stromkabel in eine Steckdose.

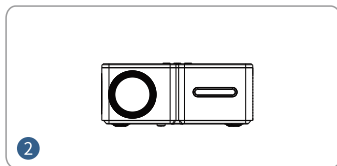

Entfernen Sie vor der Verwendung die Objektivabdeckung.

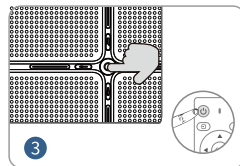

Drücken Sie die Einschalttaste, um den Projektor einzuschalten.

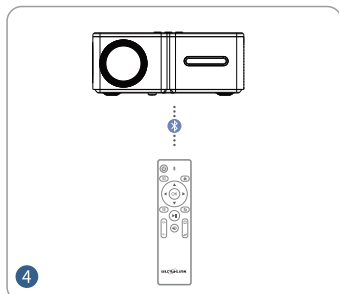

Verbinden Sie Ihre Fernbedienung über eine drahtlose Verbindung mit dem Projektor.

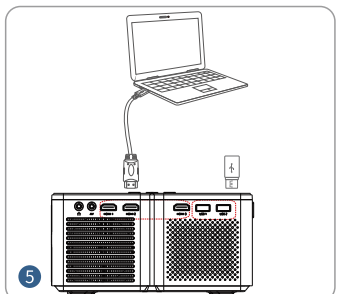

Verbinden Sie Ihr Gerät mit dem Projektor korrekt.

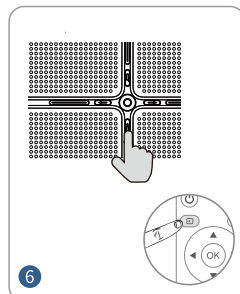

Drücken Sie die Taste Quelle und wählen Sie den gewünschten Eingang.

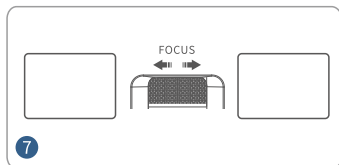

Stellen Sie den Fokusring so ein, dass Sie eine optimale

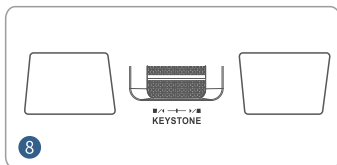

Nutzen Sie die Keystone-Korrektur, um trapezförmige Verzerrungen zu minimieren und die richtige Größe zu erhalten

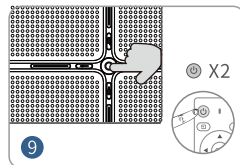

Drücken Sie die Einschalttaste zweimal, um den Projektor **Bildleistung erhalten.**

## PROJEKTIONSABSTAND UND - GRÖSSE

Eine dunkle Umgebung in Kombination mit einer guten Projektionsfläche verbessert die Klarheit der projizierten Bilder.

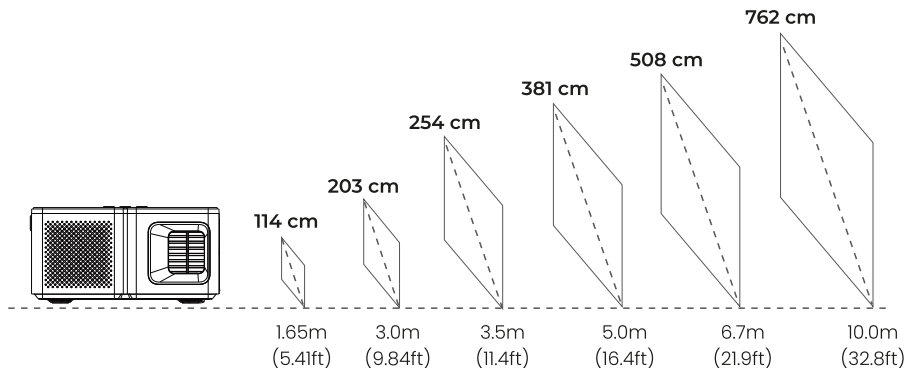

## PROJEKTIONSMODUS

Wenn Sie den Projektor an der Decke aufhängen möchten, benötigen Sie eine Projektorhalterung.

Wenn Sie in einem anderen Modus projizieren möchten, wählen Sie den entsprechenden Modus auf der Konfigurationsseite aus.



VORDERER  
TISCH

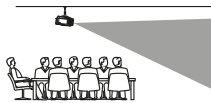

VORDERE  
DECKE



HINTERER  
TISCH

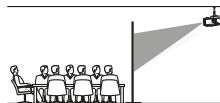

HINTERE  
DECKE

## EINGANGSQUELLE

Drücken Sie (Quelle) am Projektor oder auf der Fernbedienung, um das Quellenauswahl-Menü aufzurufen.

### A. HDMI-Anschluss

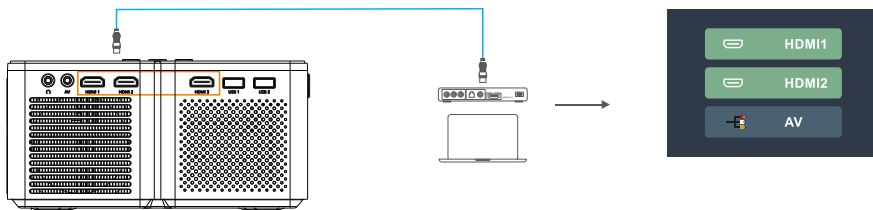

### B. AV-Anschluss

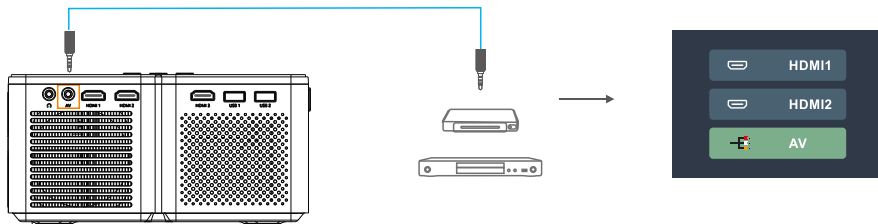

### C. USB-Anschluss

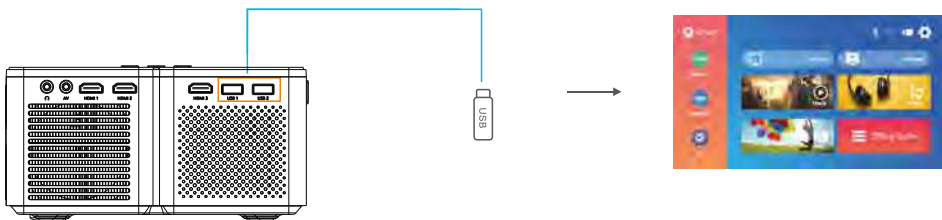

## MULTIMEDIA PLAYER EINSTELLUNGEN

Wenn Sie den Multimedia Player verwenden, wählen Sie zunächst den entsprechenden Eingang im Hauptmenü. Im Videomodus werden NUR Dateien im Videoformat auf dem USB-Stick erkannt. (Die Benutzeroberfläche der anderen drei und so weiter)

### A. Movie Player Einstellungen



Drücken Sie die  
**OK**

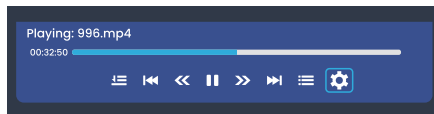
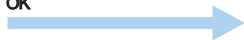

- :Wiedergabe modus
- :Zurück
- :Zurückspulen
- :Wiedergabe
- :Vorspulen
- :Weiter
- :Wiedergab eliste
- :Wiedergabeeinst ellungen

### B. Musikplayer Einstellungen

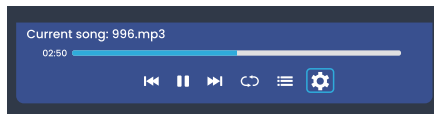

- :Zurück
- :Abspielen
- :Weiter
- :Wiedergabe modus
- :Wiedergab eliste
- :Ton-Einstellungen

### C. Picture Player Einstellungen



Drücken Sie die  
**OK**

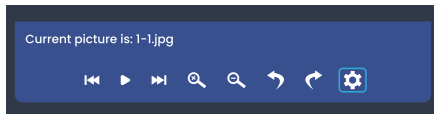

 :Zurück

 :Abspielen

 :Wei

 :Bild  
verkleinern

 :Bild  
vergrößern

 :Nach links  
verschieben

 :Nach rechts  
verschieben

 :Bildeinstellungen

### D. Office Paket Einstellungen



 :Zugriff auf den  
Account

 :Teilen

 :Datei-Konfigurati  
on

# BILD- UND TONEINSTELLUNGEN

Drücken Sie im HDMI- oder AV-Modus die Taste Menü , um die Bild- und Toneinstellungen aufzurufen.

## A. Bildeinstellungen:



<b>Bild-Modus</b>	Benutzer / Standard / Dynamisch / Moderat	
Helligkeit	0~100	
Kontrast	0~100	
Sättigung	0~100	
Schärfe	0~20	
<b>Farbtemperatur</b>	Benutzer/ Kühl/ Standard/ Warm	Rote Verstärkung : -100~100
		Grüne Verstärkung: -100~100
		Blaue Verstärkung: -100~100
<b>Standardwerte wiederherstellen</b>	Drücken, um die ursprüngliche Bildeinstellung wiederherzustellen.	

## B. Toneinstellungen:

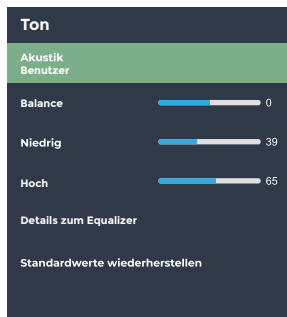

Akustik	Benutzer/ Standard/ Film/ Musik/ Sport	
<b>Balance</b>	-50~50	
<b>Niedrig</b>	0~100	
<b>Hoch</b>	0~100	
<b>Details zum Equalizer</b>	120Hz	-50~50
	500Hz	-50~50
	1,5KHz	-50~50
	5KHz	-50~50
	10KHz	-50~50
<b>Standardwerte wiederherstellen</b>	Drücken, um die ursprüngliche Toneinstellung wiederherzustellen.	

## WLAN-ANSCHLUSS UND DUAL SCREEN-FUNKTION

### WLAN-ANSCHLUSS

1. Gehen Sie auf das **Hauptmenü** > **Einstellungen** > **WLAN-Einstellungen**
2. Schalten Sie das **WLAN** ein und suchen Sie die WLAN-Liste über "WLAN hinzufügen"
3. Wählen Sie das gewünschte WLAN aus und geben Sie dann das Passwort ein, um eine Verbindung herzustellen

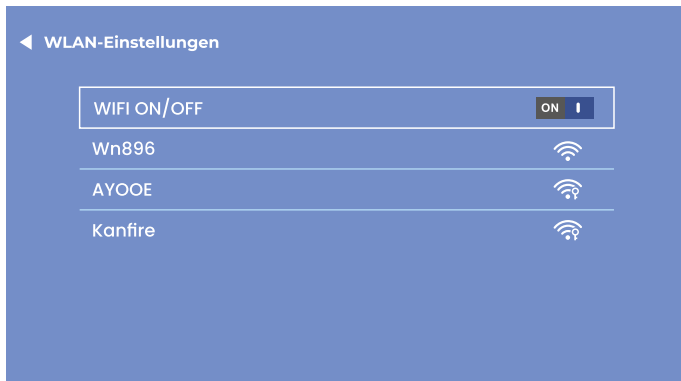

#### HINWEIS:

Die Geschwindigkeit Ihres Heimnetzwerks ist entscheidend für eine reibungslose Videowiedergabe, wenn der Bildschirm dupliziert werden soll. Vergewissern Sie sich, dass das WLAN-Signal stark genug ist und der Router nicht zu weit entfernt ist, um eine reibungslose Wiedergabe zu gewährleisten.



## BILDSCHIRM DUPLIZIEREN

### IOS CAST (Für IOS System)

1. (Hauptmenü) aufrufen, > (IOS CAST) um die folgende Seite anzuzeigen
2. Öffnen Sie auf Ihrem iOS-Gerät das Kontrollzentrum und tippen Sie auf "Bildschirm duplizieren"
3. Ein kompatibles Gerät wird gesucht
4. Wählen Sie BirdCast-XXXX aus der Liste aus, um eine Verbindung herzustellen

**ROTACAST**

Stellen Sie sicher, dass Ihr iOS-Gerät mit demselben Netzwerk wie Ihr Projektor verbunden ist



The first screenshot shows the iOS Control Center with the 'Screen Mirroring' icon highlighted. The second screenshot shows the 'Screen Mirroring' menu with 'BirdCast-70fb' selected. The third screenshot shows the 'Screen Mirroring' menu with 'BirdCast-70fb' selected and a checkmark next to it.

1. Öffnen Sie auf Ihrem iOS-Gerät das Kontrollzentrum und tippen Sie auf "Bildschirm duplizieren"
2. Ein kompatibles Gerät wird gesucht
3. wählen Sie BirdCast-70fb aus der Liste aus.

Network error  BirdCast-70fb

#### HINWEIS:

Stellen Sie sicher, dass der Projektor und Ihr iOS-Gerät mit demselben Netzwerk verbunden sind. Wenn kein WLAN-Signal vorhanden ist, öffnen Sie einen Hotspot auf Ihrem iOS-Gerät und verbinden den Projektor auf diese Weise.

## DLNA (Für iOS-Geräte)

1. Stellen Sie sicher, dass Ihr Gerät mit demselben Netzwerk wie der Projektor verbunden ist.
2. Öffnen Sie Ihre Wiedergabesoftware
3. Klicken Sie auf das **TV**-Symbol und wählen Sie den Namen des BirdCast-XXXX-Projektors aus, um eine Verbindung herzustellen

### HINWEIS:

1. Alle Funktionen des Projektors sind DLNA-kompatibel.
2. Nachdem Sie das Telefon via DLNA verbunden haben, können Sie es weiterhin normal verwenden. Das projizierte Video wird dabei weiterhin abgespielt, die Oberfläche des Mobiltelefons wird jedoch nicht synchron angezeigt.
3. Die Anwendung muss die Wiedergabe von Videos oder Screencasts unterstützen (einige Anwendungen haben Einschränkungen für Screencasts).
4. Einige Streaming-Videos können aufgrund von Urheberrechtsbeschränkungen nicht auf die Leinwand projiziert werden, dies hat nichts mit den Eigenschaften des Projektors zu tun.

## MIRACAST (Für Android-Systeme)

1. Rufen Sie das **Hauptmenü** auf **MIRACAST** um die nächste Seite anzuzeigen
2. Starten Sie auf Ihrem Android-Gerät die Funktion Multi Screen/ Wireless Viewer/ Mirror Screen/ Smart View.
3. Ein kompatibles Gerät wird gesucht
4. Wählen Sie BirdCast-XXXX aus der Liste aus, um eine Verbindung herzustellen

### ROTACAST

#### Android-Bildschirm

Ein Android-Mobiltelefon/Tablet kann mit einem Projektor verbunden werden, der auf der Wireless-Display-Technologie basiert



1. Aktivieren Sie auf Ihrem Android-Gerät das WLAN (Es muss keine Verbindung zu einem Wi-Fi-Router hergestellt werden)
2. Starten Sie die Funktion Multi Screen / Wireless Display / Mirror Screen / Smart View
3. Wählen Sie Android-70fb aus der Suchergebnisliste

### HINWEIS:

1. Bitte denken Sie daran, die WIFI-Funktion auf Ihrem Android-Gerät zu öffnen.
2. Sollte die Miracast-Verbindung getrennt werden, können Sie die Verbindung manuell in den Einstellungen wieder herstellen oder 1-2 Minuten warten, bis die Verbindung automatisch wiederhergestellt wird.

# DRAHTLOSE AUDIOVERBINDUNG

## A. Drahtlose Verbindung

1. Zur (Startseite gehen) > (Einstellungen) > (Drahtlose Konfiguration)
2. Aktivieren Sie die drahtlose Verbindungsfunktion und suchen Sie nach drahtlosen Geräten in der Nähe
3. Wählen Sie das gewünschte drahtlose Gerät für die Verbindung

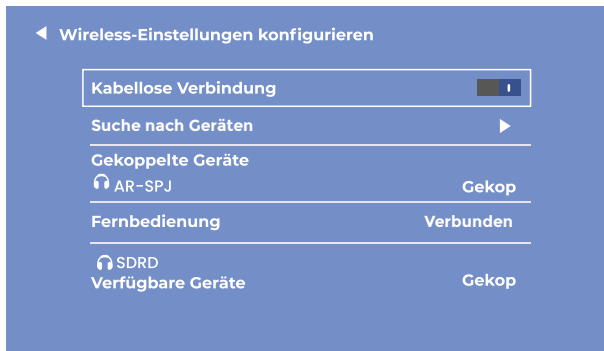

### HINWEIS:

1. Die drahtlose Funktion ist NUR für die Audioübertragung mit Audiogeräten gedacht. Videosynchronisation mit Smartphones wird NICHT unterstützt.
2. Wenn Sie Ihren Kopfhörer/Lautsprecher mit Audioanschluss anschließen möchten, trennen Sie zuerst das drahtlose Audiogerät vom Projektor.

## B. Drahtlose Fernbedienung

Bei der ersten Inbetriebnahme des Projektors wird die folgende Seite mit einer Anleitung zum Verbinden der drahtlosen Fernbedienung angezeigt.

Halten Sie die linke und rechte Taste gleichzeitig einige Sekunden lang gedrückt, um die Verbindung herzustellen. Nach dem Anschluss ist die Fernbedienung empfindlicher und die Reichweite wird erweitert.

### Kabellose Fernbedienung

1. Halten Sie die linke und rechte Taste einige Sekunden lang gedrückt, um den automatischen Kopplungsmodus zu aktivieren (EMPFOHLEN)

2. Drücken Sie die OK-Taste, um die Einstellungen der drahtlosen Verbindung des Systems für den manuellen Kopplungsmodus zu öffnen.

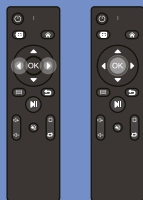

#### Zwei Fernbedienungsmodi:

1. Normale Infraroterkennung: Muss auf das Infrarotfenster des Projektors gerichtet sein und innerhalb des Infraroterkennungsbereichs arbeiten. 2. Bluetooth-Fernbedienung: Sobald die Fernbedienung über Bluetooth mit dem Projektor verbunden ist, kann sie auch außerhalb des Erfassungsbereichs verwendet werden, wodurch eine bequemere Bedienung erreicht wird.

#### Hinweis:

Sobald die Bluetooth-Fernbedienung verbunden ist, können auch andere Bluetooth-Audiogeräte problemlos angeschlossen werden.

Bitte lassen Sie die Bluetooth-Funktion des Projektors aktiviert, um sicherzustellen, dass die Bluetooth-Fernbedienung eine Verbindung herstellen und reibungslos funktionieren kann.

## PROJEKTIONSEINSTELLUNGEN

### A. Einfache Einstellung (manuelle Trapezkorrektur)

1. **Bildeinstellung anpassen**
2. Wählen Sie "Erweiterte Funktion" und drücken Sie die Taste "Rechts" ◀ oder "Links", ▶ um in den **Frontmodus zu wechseln**
3. **Manuelle Trapezkorrektur wählen**
4. Drücken Sie die Tasten Links ◀ und Rechts, ▶ um den vertikalen Trapezwinkel einzustellen ( $\pm 50^\circ$ ).



## B. Erweiterte Einstellungen (Erweiterte Trapezkorrektur)

Mit dieser Einstellung können Sie jede Ecke des projizierten Bildes unabhängig voneinander einstellen, ohne den Projektor bewegen zu müssen. Mit dieser Funktion können Sie von der Seite projizieren.

### 1. Bildeinstellungen anpassen

2. Wählen Sie "Erweiterte Trapezkorrektur" und drücken Sie die Taste "Rechts" ◀ oder "Links", ▶ um in den (Dia-Modus zu wechseln

3. (4-Punkt-Keystone wählen

4. Drücken Sie die Pfeiltasten, ↕ um den Winkel einzustellen, und drücken Sie die OK-Taste, um zur nächsten Eck-Einstellung zu wechseln.

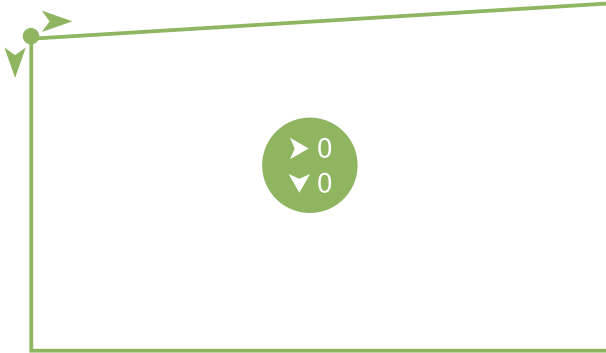

"OK" Wählen Sie "↕" **Anpassen** "↶" Zurück "☰" Neustart

HINWEIS: Wenn Sie die Standardeinstellungen wiederherstellen möchten, drücken Sie Menü ☰ Zurücksetzen.

## C. Digitaler Zoom

1. Bildeinstellungen vornehmen

2. Digitalen Zoom wählen

3. Drücken Sie die Abwärtstaste, ▼ um das Bild zu verkleinern (100%-50%) und die Aufwärtstaste, ▲ um das Bild zu vergrößern (50%-100%).



" Einstellen



" Zurück



" Zurücksetzen

HINWEIS: Wenn Sie die Standardeinstellungen wiederherstellen möchten, drücken Sie Menü  Zurücksetzen.

## Garantiepolitik

Dieses Produkt entspricht dem im Land des Kaufs geltenden Gewährleistungsrecht. Wenn Sie ein Problem haben, das nicht gelöst werden kann, müssen Sie auf das Internet [www.prixton.com](http://www.prixton.com) zugreifen und auf die Kontaktoption klicken, um uns Ihr Unterstützungsformular zu senden.

Die elektrischen und technischen Eigenschaften, die hier genannt wurden, entsprechen typischen Geräten und können ohne Vorankündigung geändert werden, um ein besseres Gerät anzubieten.

## Vereinfachte EU-einverständniserklärung

La Trastienda Digital SL als Inhaber der Handelsmarke Prixton, mit dem Standort Avenida Cervantes 49, módulo 25, Basauri 48970, Bizkaia, erklärt hiermit, dass das im Folgenden detaillierte radioelektrische Gerät:

MARKE	MODEL	BESCHREIBUNG	KATEGORIE
Prixton	KUBRICK	Projector	Image

der EU-Richtlinie 2014/53/UE des Europaparlaments und –rats vom 16. April 2014 entspricht.

Der komplette Text der EU-Einverständniserklärung kann unter dem folgenden Link **abgerufen werden:**

[www.prixton.com](http://www.prixton.com) LA TRASTIENDA DIGITAL



## LISTA DA EMBALAGEM

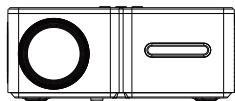

Projektor Miró



Comando

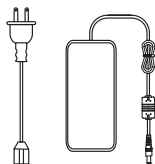

Power Cable



Manual do utilizador

## AVISO

### Recomendado

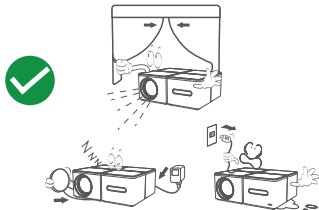

### NÃO recomendado



## FUNÇÃO VISÃO GERAL

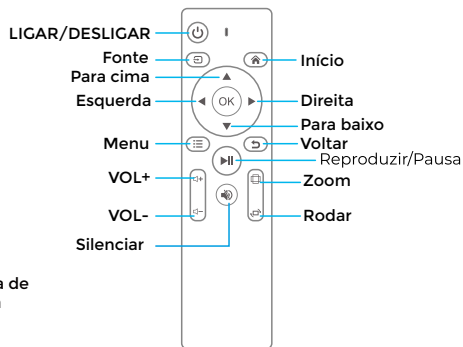
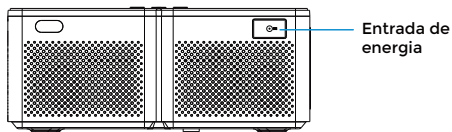
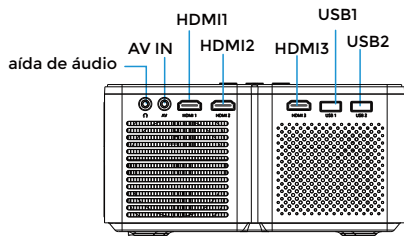
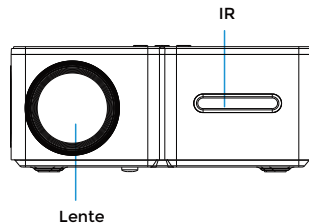
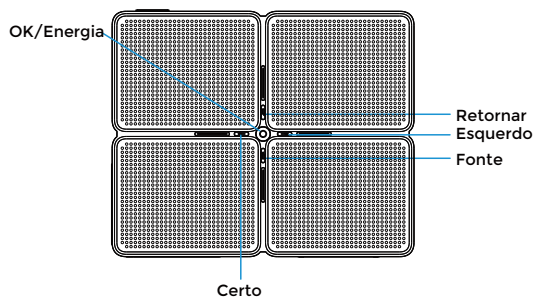

## INÍCIO RÁPIDO

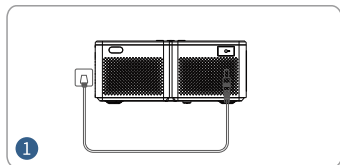

Ligue o cabo de alimentação a uma tomada elétrica.

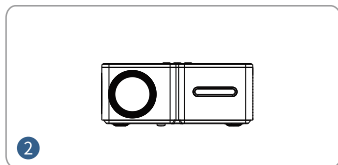

Remova a tampa da lente antes de usar.

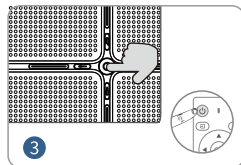

Prima o botão de ligar/desligar para ligar o projetor.

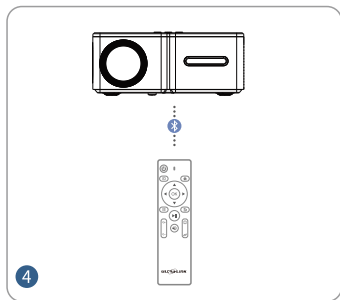

Ligue o seu comando ao projetor através da Ligação sem fios.

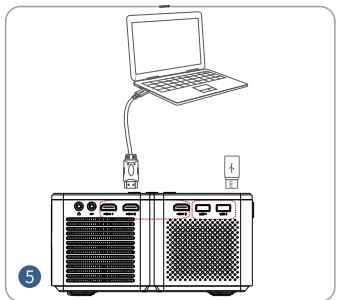

Ligue o dispositivo ao projetor corretamente.

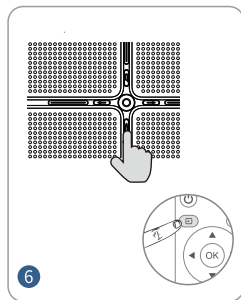

Prima o botão Fonte e selecione a fonte de entrada correta.

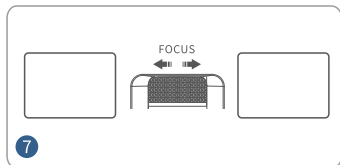

Ajuste o anel de foco para obter o melhor desempenho de imagem.

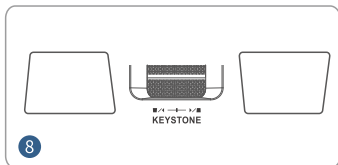

Ajuste a distorção trapezoidal para obter o tamanho correto

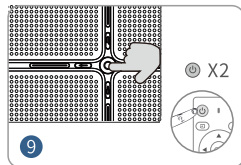

Prima o botão de ligar/desligar duas vezes para desligar o projetor

## DISTÂNCIA e TAMANHO DA PROJEÇÃO

Um ambiente escuro combinado com um bom ecrã de projeção vai melhorar a clareza das imagens projetadas.

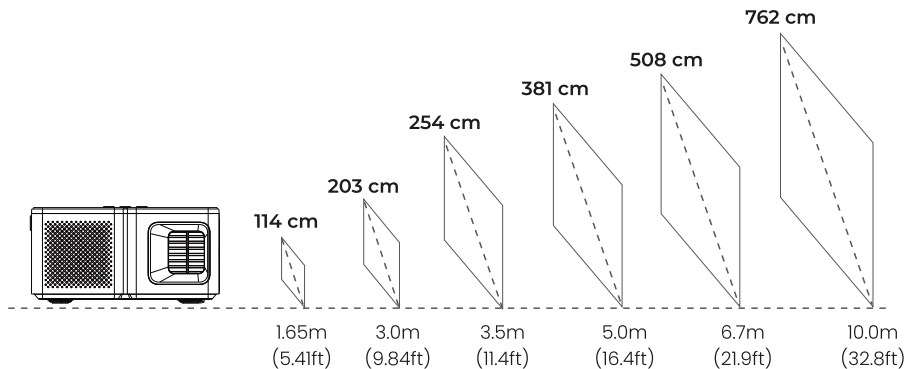

## MODO DE PROJEÇÃO

Se pretender pendurar o projetor no teto, vai precisar de um suporte para projetor.

Se pretender projetar num modo diferente, seleccione o modo correspondente na página de definições.



MESA À  
FRENTE

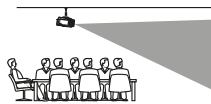

TETO À FRENTE

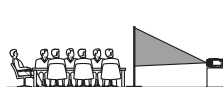

MESA ATRÁS

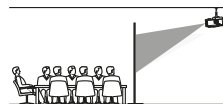

TETO ATRÁS

## ENTRADA FONTE

Prima (Fonte ) no projetor ou no comando para aceder à interface da Fonte de Entrada.

### A. Ligação HDMI

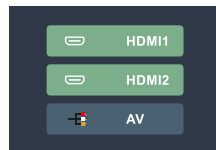
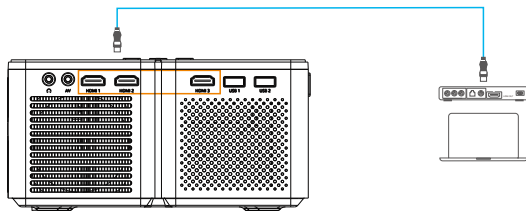

### B. Ligação AV

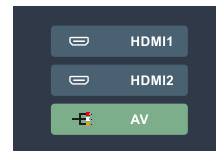
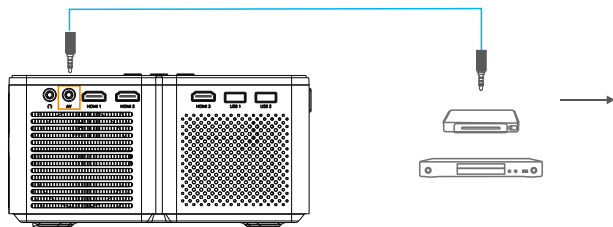

### C. Ligação USB

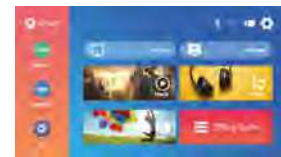
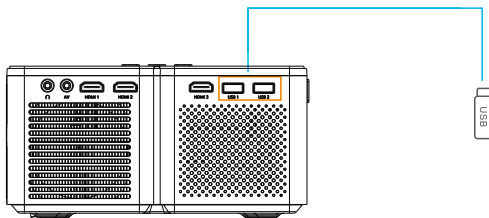

## DEFINIÇÕES DO LEITOR MULTIMÉDIA

Quando utilizar o leitor multimédia, escolha primeiro a entrada correta na página inicial. Se introduzir Filme, APENAS vão ser detetados ficheiros de formato de vídeo no dispositivo USB. (A interface dos outros três é e assim sucessivamente)

### A. Definições do leitor de filmes



Prima o botão OK

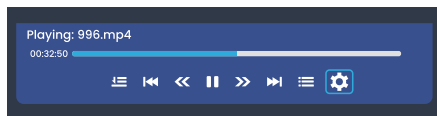

- :Lista de reprodução
- :Anterior
- :Recuar
- :Reproduzir
- :Avanço rápido
- :Seguinte
- :Definições de reprodução

### B. Definições do leitor de música

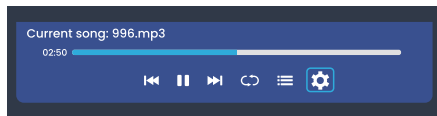

- :Anterior
- :Reproduzir
- :Seguinte
- :Modo de reprodução
- :Lista de reprodução
- :Definições de som

### C. Definições do leitor de imagens



Prima o botão **OK**

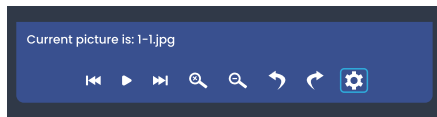

:Anterior

:Reproduzir

:Seg

:Afastar

:Aumentar

:Virar para a esquerda

:Virar para a direita

:Definições de imagem

### D. Definições do pacote Office



:Acesso à conta

:Partilhar

:Configuração de ficheiros

## DEFINIÇÕES DE IMAGEM E SOM

No modo HDMI ou AV, prima o botão Menu  para aceder às definições de imagem e som.

### A. Definições de imagem:

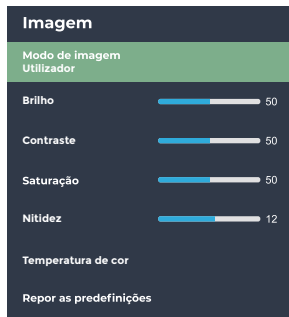

Modo de imagem	Utilizador / Padrão / Dinâmico / Moderado	
Brilho	0~100	
Contraste	0~100	
Saturação	0~100	
Nitidez	0~20	
Temperatura de cor	Utilizador/ Frio/ Padrão/ Quente	Vermelho: -100~100
		Verde: -100~100
		Azul: -100~100
Repór as predefinições	Prima para repór a definição de imagem original.	

### B. Definições de som:

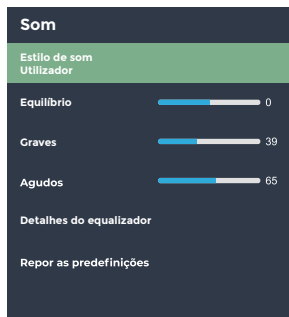

Estilo de som	Utilizador/ Padrão/ Filme/ Música/ Desporto	
Equilíbrio	-50~50	
Graves	0~100	
Agudos	0~100	
Detalhes do equalizador	120Hz	-50~50
	500Hz	-50~50
	1.5KHz	-50~50
	5KHz	-50~50
	10KHz	-50~50
Repór as predefinições	Prima para repór a definição de som original.	



## LIGAÇÃO WIFI E DUPLICAR ECRÃ

### LIGAÇÃO WIFI

1. Aceda à [página inicial](#) > [Definições](#) > [Definições de WIFI](#)
2. Ligue o [WIFI](#) e procure a lista de WIFI através de "Adicionar WIFI"
3. Escolha o seu WIFI e, de seguida, introduza a palavra-passe para estabelecer a ligação

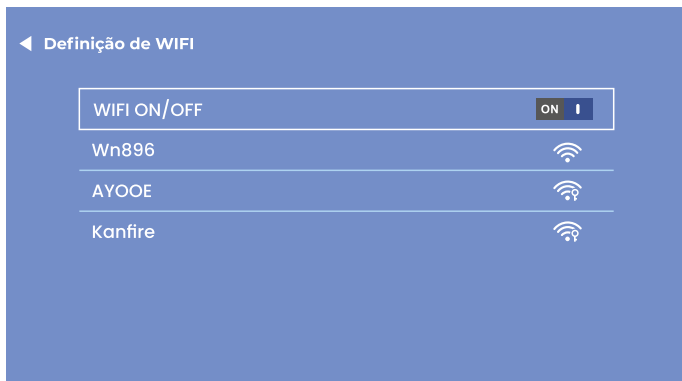

NOTA:

**Se precisar de duplicar o ecrã, a velocidade da sua rede doméstica está diretamente relacionada com a suavidade da reprodução de vídeo. Certifique-se de que a rede é boa e não está longe do router para obter uma reprodução mais suave.**

## DUPLICAR ECRÃ

### IOS CAST (Para IOS System)

1. Aceda à [página inicial](#) > [IOS CAST](#) para visualizar a seguinte página
2. No seu dispositivo iOS, abra o Centro de Controlo e toque em Duplicar ecrã
3. A procurar um dispositivo que possa ser espelhado
4. Selecione BirdCast-XXXX na lista para estabelecer ligação

#### ROTACAST

Certifique-se de que o seu dispositivo iOS está ligado à mesma rede que o projetor



The first screenshot shows the Control Center with 'Screen Mirroring' highlighted. The second screenshot shows the 'Screen Mirroring' menu with 'BirdCast-70fb' selected. The third screenshot shows the 'Screen Mirroring' menu with 'BirdCast-70fb' checked and a confirmation checkmark.

1. No seu dispositivo iOS, abra o Centro de Controlo e toque em Duplicar ecrã
2. A procurar dispositivos que possam ser espelhados
3. Selecione BirdCast-70fb na lista.

Network error  BirdCast-70fb

#### NOTA:

Certifique-se de que o projetor e o seu dispositivo iOS estão ligados à mesma rede Wi-Fi. Se não houver WIFI, abra um ponto de acesso no seu dispositivo IOS e ligue o projetor ao mesmo.

## DLNA (Para iOS dispositivos iOS)

1. Certifique-se de que o seu dispositivo está ligado à mesma rede que o projetor.
2. **Abra o seu software de reprodução de vídeo**
3. Clique no ícone  e selecione o nome do projetor BirdCast-XXXX para o ligar

NOTA:

1. **A ligação DLNA pode funcionar em qualquer página do projetor.**
2. Após a ligação através de DLNA, o telemóvel pode continuar a ser utilizado normalmente, o vídeo projetado vai continuar a ser reproduzido e a interface do telemóvel não vai ser apresentada de forma sincronizada.
3. A aplicação tem de suportar a reprodução de videografia ou de screencast (algumas aplicações têm restrições ao screencast).
4. Alguns vídeos de streaming não podem ser projetados no ecrã devido a restrições de direitos de autor, o que não tem nada a ver com o projetor em si.

## MIRACAST (Para sistemas Android)

1. Aceda à [página inicial](#) > [MIRACAST](#) para visualizar a seguinte página
2. No seu dispositivo Android, inicie a função Ecrã múltiplo/Visualização sem fios/Duplicar ecrã/Vista inteligente.
3. **A procurar um dispositivo que possa ser espelhado**
4. Selecione BirdCast-XXXX na lista para estabelecer ligação

**ROTACAST**

**Ecrã Android**  
Para ligar um telemóvel/tablet Android a um projetor baseado na tecnologia WiFi-Display



1. No seu dispositivo Android, ative a WLAN (não é necessário ligar a um router Wi-Fi)  
2. Iniciar a função Ecrã múltiplo / Visualização sem fios / Duplicar ecrã / Visão inteligente  
3. Selecione Android-70fb na lista de resultados da pesquisa

NOTA:

1. Não se esqueça de abrir a função WIFI no seu dispositivo Android.
2. Quando desligar o Miracast, volte a ligar manualmente nas definições ou aguarde 1-2 minutos para que a ligação seja restabelecida automaticamente.

# LIGAÇÃO ÁUDIO SEM FIOS

## A. Ligação sem fios

1. Aceda à (página inicial) > (Definições) > (Definições sem fios)
2. Ative a função de ligação sem fios e procure dispositivos sem fios nas proximidades
3. Escolha o dispositivo sem fios correto para estabelecer ligação

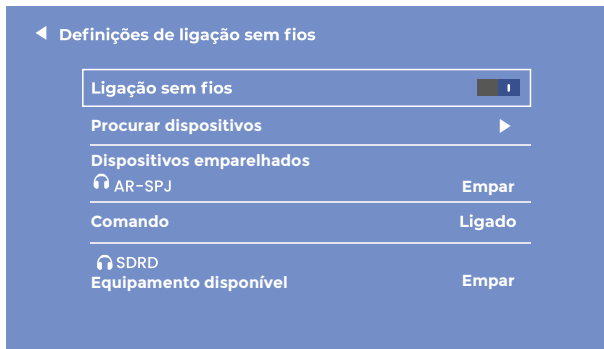

### NOTA:

1. A função sem fios destina-se APENAS à transferência de áudio com dispositivos de áudio. NÃO suporta a sincronização de vídeo com smartphones.
2. Se pretender ligar os seus headphones/coluna à porta de áudio, desligue primeiro o dispositivo áudio sem fios do projetor.

## B. Comando por ligação sem fios

Quando ligar o projetor pela primeira vez, vai aparecer a seguinte página para orientar a ligação do comando sem fios. Mantenha premidos os botões esquerdo e direito ao mesmo tempo durante alguns segundos para estabelecer a ligação. Uma vez ligado, o funcionamento do comando vai ser mais sensível e a cobertura será maior.

### Comando por ligação sem fios

1. Mantenha premidas as teclas esquerda e direita durante alguns segundos para entrar no modo de emparelhamento automático (RECOMENDADO)
2. Prima o botão OK para aceder às definições de ligação sem fios do sistema para o modo de emparelhamento manual.



Dois modos do comando:

1. **Deteção de infravermelhos comum:** tem de ser apontado para a janela de infravermelhos do projetor e funcionar dentro do alcance de deteção de infravermelhos.
2. **Comando por Bluetooth:** Quando o comando é ligado ao projetor através de Bluetooth, deixa de estar limitado pela área de deteção, tornando-o mais sensível e prático de utilizar.

**Nota:**

Uma vez ligado o comando Bluetooth, é possível ligar outros dispositivos de áudio Bluetooth sem qualquer problema. **Mantenha o Bluetooth do projetor ativado para garantir que o comando Bluetooth pode ligar e funcionar normalmente.**

## DEFINIÇÕES DE PROJEÇÃO

### A. Definição simples (keystone manual)

1. Introduzir definição de imagem
2. Selecione a tecla Avancada prima o botão Direito ◀ ou Esquerdo ▶ para converter para o Modo Frontal
3. Selecione Keystone manual
4. Prima os botões Esquerdo ◀ e Direito ▶ para ajustar o ângulo trapezoidal vertical ( $\pm 50^\circ$ ).

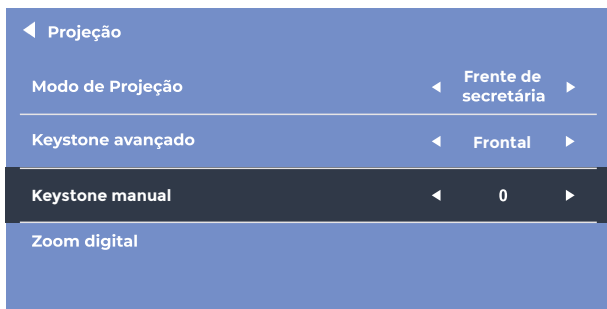

## B. Definição avançada (keystone avançado)

Esta definição permite-lhe ajustar independentemente cada canto da imagem projetada sem ter de mover o projetor. Com esta função, pode projetar a partir da lateral.

1. Introduzir (definições de imagem)
2. **Selecione Keystone Avançada**, prima o botão **Direito** ◀ ou **Esquerdo** ▶ para converter para o **(Modo Diapositivo)**
3. (Selecione Keystone de 4 pontos)
4. Prima os botões de direção ◀ ▶ para ajustar o ângulo, prima o botão OK para saltar para a definição do canto seguinte.

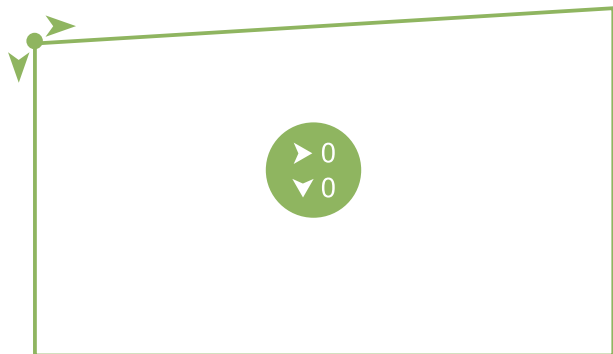

“OK” Selecionar “◀ ▶” Ajustar “↶” Voltar “☰” Reiniciar

NOTA: Se pretender voltar às definições originais, prima Menu ☰ Repor.

## C. Zoom digital

1. (Introduzir definições de imagem)

2. Escolha **(Zoom digital)**

3. Prima o botão Para baixo ▼ para diminuir o zoom (100%-50%) e o botão Para cima ▲ para aumentar o zoom (50%-100%).



" Configurar



" Voltar



" Reiniciar

NOTA: Se pretender voltar às definições originais, prima Menu  Repor.



## Política de garantia

Em cumprimento do estabelecido no Decreto-Lei n.º 84/2021 <https://dre.pt/dre/detalhe/decreto-lei/84-2021-172938301>, colocamos à disposição dos interessados toda a informação necessária para poder exercer todos os direitos de desistir de acordo com as normas contidas nesta lei, dando por cumpridos os requisitos que a lei exige ao vendedor no contrato de venda.

As características técnicas e eléctricas que aqui se indicam podem ser válidas para outras unidades semelhantes às nossas e poderão ser trocadas sem aviso prévio com o objetivo de oferecer um equipamento melhor.

## Declaração De Conformidade Simplificada

Pela presente, a La Trastienda Digital SL, na qualidade de proprietária da marca comercial Prixton, com sede no Avenida Cervantes 49, módulo 25, Basauri 48970, Bizkaia, declara que o tipo de equipamento radioelétrico que de seguida se expõe:

MARCA	MODELO	DESCRIÇÃO	CATEGORIA
Prixton	KUBRICK	Projector	Image

Está em conformidade com a Diretiva 2014/53/UE do Parlamento Europeu e do Conselho de 16 de abril de 2014.

O texto completo da declaração UE de conformidade pode ser consultado no seguinte endereço Web:

[www.prixton.com](http://www.prixton.com)

LA TRASTIENDA DIGITAL

## LIJST INHOUD VERPAKKING



Projector Miró



Afstandsbediening

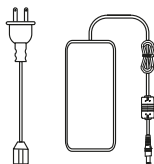

Power Cable



Gebruiksaanwijzing

## OPMERKING

### Aanbevolen

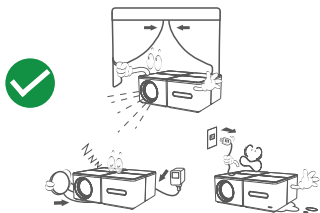

### NIET aanbevolen



## FUNCTIE OVERZICHT

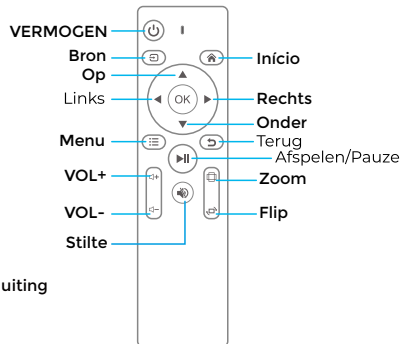
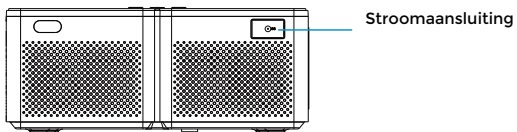
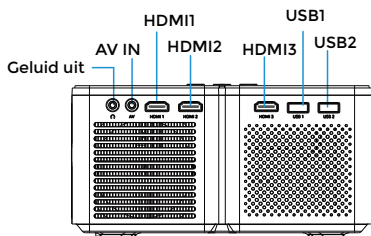
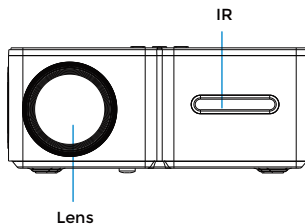
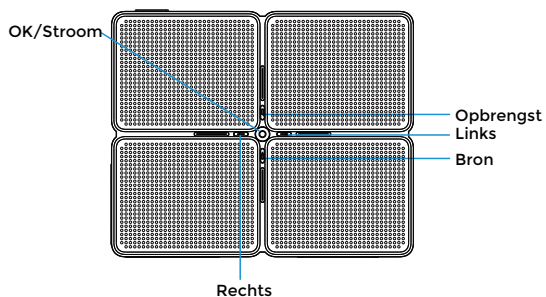

## SNELSTART

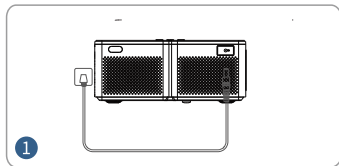

1 Steek de stekker in een stopcontact.

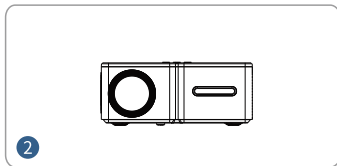

2 Verwijder de lensdop voor gebruik.

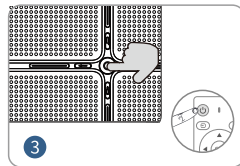

3 Druk op de aan/uit-knop om de projector in te schakelen.

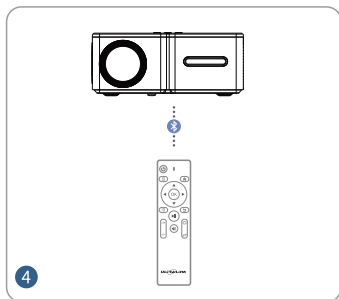

4 Sluit de afstandsbediening aan op de projector via een draadloze verbinding.

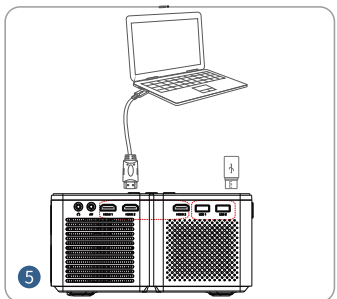

5 Sluit je apparaat correct aan op de projector.

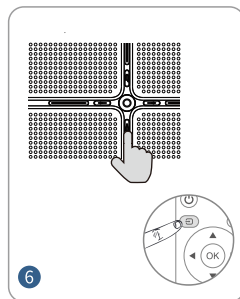

6 Druk op de Source-knop en selecteer de juiste ingangsbron.

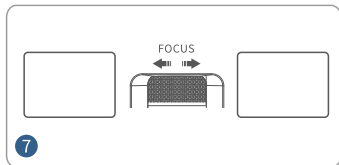

7 Gebruik de scherpestelling voor de beste beeldscherpte beeldprestaties.

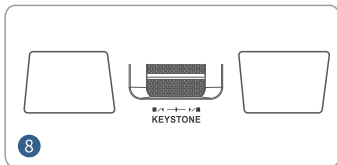

8 Pas de keystone-vertanding aan om de juiste grootte te verkrijgen

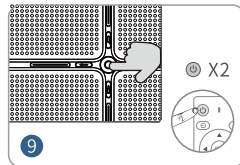

9 Druk tweemaal op de aan/uit-knop om de projector uit te schakelen

## AFSTAND en GROOTTE VAN DE PROJECTIE

Een donkere omgeving in combinatie met een goed projectiescherm verbetert de helderheid van de geprojecteerde beelden.

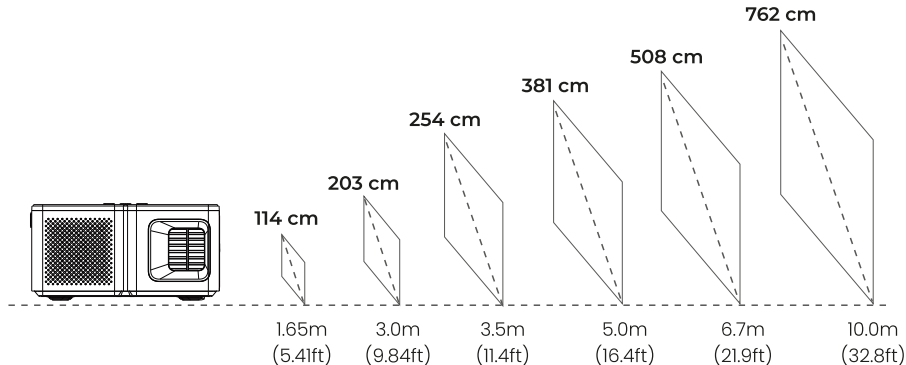

## PROJECTIEMODUS

Als je de projector aan het plafond wilt hangen, heb je een projectorbeugel nodig.

Als je in een andere modus wilt projecteren, selecteer je de overeenkomstige modus op de configuratiepagina.



TAFEL  
VOORAAN

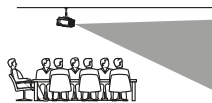

OVERKAPPING  
VOORAAN

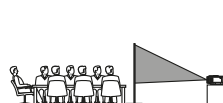

TAFEL  
ACHTERAAN

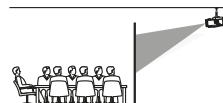

OVERKAPPING  
ACHTERAAN

## BRON INVOER

Druk op (Source ) op de projector of op de afstandsbediening om de ingangsbroninterface te openen.

### A. HDMI-aansluiting

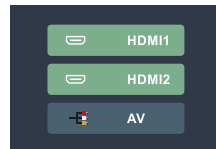
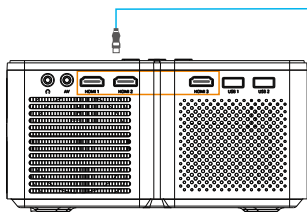

### B. AV-aansluiting

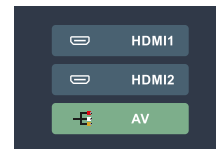
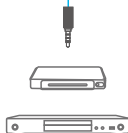
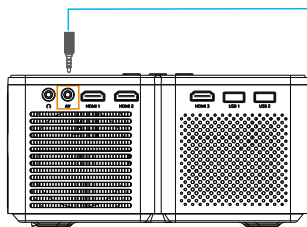

### C. USB-aansluiting

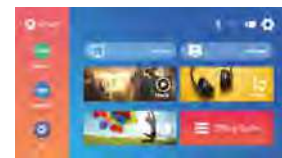
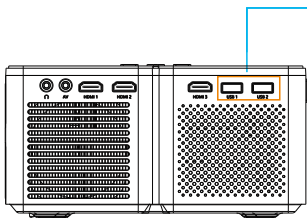

## INSTELLINGEN MEDIASPELER

Als je de mediaspeler gebruikt, kies dan eerst het juiste item op de startpagina. Als je vanuit de film-modus werkt, worden ALLEEN videoformaatbestanden op de USB-stick gedetecteerd. (De interface van de andere drie enzovoort)

### A. Instellingen filmspeler



Druk op de **OK**

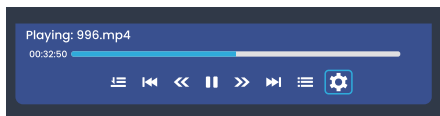
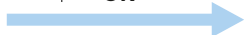

- :Afspeelmodus
- :Vorige
- :Terugspoelen
- :Afspelen
- :Snel vooruit
- :Volgende
- :Afspeellijst
- :Afspeelinstellingen

### B. Instellingen muzikspeler

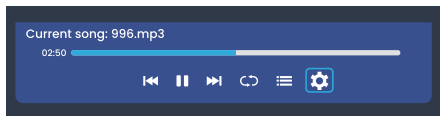

- :Vorige
- :Afspelen
- :Volgende
- :Afspeelmodus
- :Afspeellijst
- :Geluidsinstellingen

### C. Instellingen afspelen van afbeeldingen



Druk op de menuknop **OK**

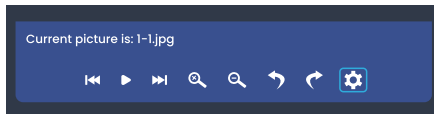

:Vorige

:Afspelen

:Seg

:Zoom uit

:Vergroten

:Naar links draaien

:Naar rechts draaien

:Beeldinstellingen

### D. Instellingen Office-pakket



:Toegang account

:Delen

:Bestandsconfiguratie



## BEELD- EN GELUIDSINSTELLINGEN

Druk in de HDMI- of AV-modus op de toets Menu  om de beeld- en geluidsinstellingen te openen.

### A. Beeldinstellingen:



**Afbeelding**

Beeldmodus  
Gebruiker

Helderheid 50

Contrast 50

Verzadiging 50

Scherpste 12

Kleurtemperatuur

Standaardinstellingen herstellen

Beeldmodus	Gebruiker / Standaard / Dynamisch / Matig	
Helderheid	0-100	
Contrast	0-100	
Verzadiging	0-100	
Scherpte	0-20	
Kleurtemperatuur	Gebruiker/ Koel/ Standaard/ Warm	Rode versterking: -100~100
		Groene versterking: -100~100
		Blauwe versterking: -100~100
Standaardinstellingen herstellen	Druk op om de oorspronkelijke beeldinstelling te herstellen.	

### B. Geluidsinstellingen:



**Geluid**

Geluidsstijl  
Gebruiker

Evenwicht 0

Bassen 39

Hoge tonen 65

Details equalizer

Standaardinstellingen herstellen

Geluidsstijl	Gebruiker/ Standaard/ Film/ Muziek/ Sport	
Evenwicht	-50-50	
Bassen	0-100	
Hoge tonen	0-100	
Details equalizer	120Hz	-50-50
	500Hz	-50-50
	1.5KHz	-50-50
	5KHz	-50-50
	10KHz	-50-50
Standaardinstellingen herstellen	Prima para repor a definição de som original.	

## WIFI-VERBINDING EN SCHERM SPIEGELEN

### WIFI-VERBINDING

1. Ga naar de [startpagina](#) > [instellingen](#) > [WIFI-instellingen](#)
2. Schakel [\(WIFI\)](#) in en zoek in de WIFI-lijst via "WIFI toevoegen"
3. Kies je WIFI en voer het wachtwoord in om verbinding te maken

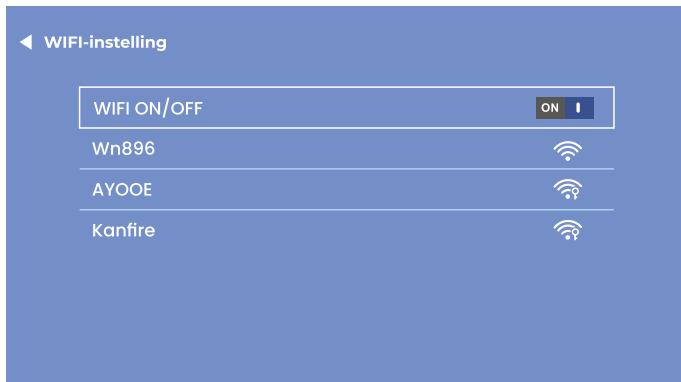

#### OPMERKING:

Als je het scherm moet dupliceren, is de snelheid van je thuisnetwerk direct gerelateerd aan hoe vloeiend video afgespeeld wordt. Zorg ervoor dat het netwerk goed is en verwijder je niet te ver van de router voor een vloeiendere weergave.

## SCHERM SPIEGELEN

### IOS CAST (Voor IOS-systeem)

1. Ga naar de [startpagina](#) > [IOS CAST](#) om de volgende pagina weer te geven
2. Open op je iOS-apparaat het Control Centre en tik op Scherm spiegelen
3. Op zoek naar een apparaat dat kan worden weerspiegeld
4. Selecteer BirdCast-XXXX uit de lijst om verbinding te maken

#### ROTACAST

Zorg ervoor dat je iOS-apparaat is aangesloten op hetzelfde netwerk als je projector



1. Open op je iOS-apparaat het Control Centre en tik op Scherm spiegelen
2. Op zoek naar apparaten die kunnen worden weerspiegeld
3. Selecteer BirdCast-70fb in de lijst.

 Network error  BirdCast-70fb

#### OPMERKING:

Zorg ervoor dat de projector en je iOS-apparaat op hetzelfde Wifi-netwerk zijn aangesloten. Als er geen WIFI is, open dan een hotspot op je IOS-apparaat en verbind de projector daarmee.

## DLNA (Voor iOS-apparaten)

1. Zorg ervoor dat je apparaat is aangesloten op hetzelfde netwerk als de projector.
2. **Open je software voor het afspelen van video**
3. Klik op het  pictogram en selecteer de naam van de BirdCast-XXXX projector om deze aan te sluiten

### OPMERKING:

1. De DLNA-verbinding kan werken op elke pagina van de projector.
2. Na het verbinden via DLNA kan de telefoon nog steeds normaal gebruikt worden; de geprojecteerde video blijft afspelen en **de interface van de mobiele telefoon wordt niet synchroon weergegeven.**
3. De applicatie moet videografie of het afspelen van screencasts ondersteunen (sommige applicaties hebben beperkingen voor screencasts).
4. Sommige streaming-video's kunnen niet op het scherm worden geprojecteerd vanwege auteursrechtelijke beperkingen, wat niets te maken heeft met de projector zelf.

## MIRACAST (voor Android-systemen)

1. Ga naar de [startpagina](#) > [MIRACAST](#) om de volgende pagina weer te geven
2. Start op je Android-apparaat de functie Meerdere schermen / Draadloze weergave / Scherm spiegelen / Smart View-functie.
3. Op zoek naar een apparaat dat kan worden gespiegeld
4. Selecteer BirdCast-XXXX uit de lijst om verbinding te maken

### ROTACAST

**Android-scherm**  
Een mobiele Android-telefoon/tablet verbinden met een projector op basis van WiFi-Display-technologie



1. Activeer WLAN op je Android-toestel (je hoeft geen verbinding te maken met een WIFI-router)
2. Start Meerdere schermen / Draadloze weergave / Scherm spiegelen / Smart View-functie
3. Selecteer Android-70fb in de lijst met zoekresultaten

### OPMERKING:

1. Vergeet niet om de WIFI-functie op je Android-apparaat te openen.
2. Als je de verbinding met Miracast verbreekt, maak dan handmatig opnieuw verbinding in de instellingen of wacht 1 tot **2 minuten tot de verbinding automatisch wordt hersteld.**

## DRAADLOZE AUDIOVERBINDING

### A. Draadloze verbinding

1. Ga naar de [homepage](#) > [Instellingen](#) > [Draadloze instellingen](#)
2. Activeer de draadloze verbindingfunctie en zoek draadloze apparaten in de buurt
3. Kies het juiste draadloze apparaat om verbinding mee te maken

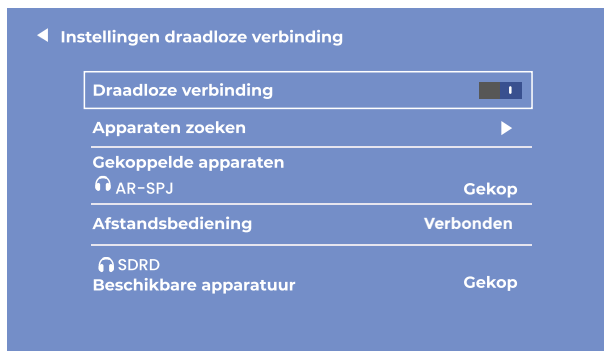

#### OPMERKING:

1. De draadloze functie is ALLEEN bedoeld voor audio-overdracht met audioapparaten. Videosynchronisatie met smartphones wordt NIET ondersteund.
2. Als je je hoofdtelefoon/luidspreker met audiopoort wilt aansluiten, moet je eerst het draadloze audioapparaat loskoppelen van de projector.

## B. Afstandsbediening met draadloze

Bij de eerste keer opstarten van de projector zal de volgende pagina verschijnen om het aansluiten van de draadloze afstandsbediening te begeleiden.

Houd de linker- en rechterknop tegelijkertijd enkele seconden ingedrukt om de verbinding tot stand te brengen. Eenmaal aangesloten zal de afstandsbediening gevoeliger zijn en een groter bereik hebben.

### Afstandsbediening met draadloze

1. Mantenha premidas as teclas esquerda e direita durante alguns segundos para entrar no modo de emparelhamento automático (RECOMENDADO)
2. Prima o botão OK para aceder às definições de ligação sem fios do sistema para o modo de emparelhamento manual.



Twee modi voor de afstandsbediening:

1. Gewone infrarooddetectie: moet gericht zijn op het infraroodvenster van de projector en werken binnen het infrarooddetectiegebied.
2. Bluetooth-afstandsbediening: zodra de afstandsbediening via Bluetooth is aangesloten op de projector, wordt deze niet langer beperkt door het detectiegebied, waardoor deze gevoeliger en handiger in het gebruik is.

#### Let op:

Zodra de Bluetooth-afstandsbediening is aangesloten, kunnen andere Bluetooth-audioapparaten ook zonder problemen worden aangesloten.

Houd de Bluetooth van de projector ingeschakeld om ervoor te zorgen dat de Bluetooth-afstandsbediening verbinding kan maken en normaal kan werken.

## PROJECTIE-INSTELLINGEN

### A. Enkelvoudige instelling (handmatige keystone)

1. **Beeldaanpassing invoeren**
2. Kies de toets **Geavanceerd**, druk op de knop Rechts ◀ of Links ▶ om het te converteren naar **Frontmodus**
3. **Kies Handmatige keystone**
4. Druk op de knoppen Links ◀ en Rechts ▶ om de verticale keystone-vertorming aan te passen ( $\pm 50^\circ$ ).

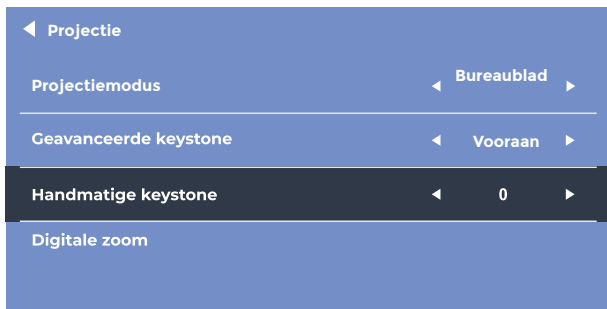

## B. Geavanceerde instelling (geavanceerde keystone)

Met deze instelling kun je elke hoek van het geprojecteerde beeld onafhankelijk aanpassen zonder dat je de projector hoeft te verplaatsen. Met deze functie kun je vanaf de zijkant projecteren.

### 1. Afbeeldingsinstellingen invoeren

2. Kies **Geavanceerde Keystone** druk op de knop Rechts ◀ of Links ▶ om te converteren naar **Dia-modus**

3. **Kies 4-punts keystone**

4. Druk op de richtingstoetsen om de hoek aan te passen, druk op OK om naar de volgende hoekinstelling te gaan.



“OK” Selecteer “↔” Aanpassen “↶” Terug “☰” Opnieuw opstarten

OPMERKING: Als je terug wilt naar de oorspronkelijke instellingen, druk je op Menu ☰ Reset



## C. Digitale zoom

1. Afbeeldingsinstellingen invoeren

2. Kies (Digitale zoom)

3. Druk op de knop Omlaag▼ om uit te zoomen (100%-50%) en op de knop Omhoog▲ om in te zoomen (50%-100%).



" Aanpassen



" Terug



" Opnieuw

OPMERKING: Als je terug wilt naar de oorspronkelijke instellingen, druk je op Menu  **Reset**.

## Garantie beleid

Dit product voldoet aan de in het land van aankoop geldende garantiewetgeving. Als u een probleem hebt dat u niet kunt oplossen, moet u naar [www.prixton.com](http://www.prixton.com) gaan en op de contactoptie klikken om ons uw assistentieformulier toe te sturen.

Deze technische en elektrische specificaties kunnen te allen tijde en zonder voorafgaande kennisgeving worden gewijzigd om het apparaat nog te verbeteren.

## Vereenvoudigde EU-conformiteitsverklaring

Hierbij verklaart La Trastienda Digital SL, als eigenaar van het handelsmerk Prixton, en gevestigd in het Avenida Cervantes 49, módulo 25, Basauri 48970, Bizkaia, dat de **radioapparatuur die hierna wordt beschreven:**

MERK	MODEL	BESCHRIJVING	CATEGORIE
Prixton	KUBRICK	Projector	Image

Strookt met Richtlijn 2014/53/EU van het Europees Parlement en de Raad van 16 april 2014.

De volledige tekst van de EU-conformiteitsverklaring is te vinden op de volgende **internetsite:**  
[www.prixton.com](http://www.prixton.com)

LA TRASTIENDA DIGITAL

# PRIXTON

